

RANGE ROVER SPORT



ABOVE & BEYOND





BY APPOINTMENT TO
HM THE QUEEN
MANUFACTURERS OF
MOTOR VEHICLES
JAGUAR LAND ROVER LIMITED
COVENTRY



BY APPOINTMENT TO
HRH THE DUKE OF EDINBURGH
MANUFACTURERS OF
MOTOR VEHICLES
JAGUAR LAND ROVER LIMITED
COVENTRY



BY APPOINTMENT TO
HRH THE PRINCE OF WALES
MANUFACTURERS OF
MOTOR VEHICLES
JAGUAR LAND ROVER LIMITED
COVENTRY



ABOVE & BEYOND

Ever since the first Land Rover vehicle was conceived in 1947, we have built vehicles that challenge what is possible. These in turn have challenged their owners to explore new territories and conquer difficult terrains. Our vehicles epitomise the values of the designers and engineers who have created them. Each one instilled with iconic British design cues, delivering capability with composure. Which is how we continue to break new ground, defy conventions and encourage each other to go further. Land Rover truly enables you to make more of your world, to go above and beyond.









RANGE ROVER SPORT

Range Rover Sport is undoubtedly our most dynamic SUV ever. Performance and capability are exceptional and a range of advanced technologies deliver an assured, confident driving experience. With sportier design cues and a powerful, muscular stance, this is a vehicle designed for impact.

CONTENTS

INTRODUCTION

Introducing Range Rover Sport 6

DESIGN

Exterior 11

Interior 13

PERFORMANCE AND CAPABILITY

Plug-in Hybrid Electric Vehicle 14

Engines and Transmission 18

Legendary Breadth of Capability 21

TECHNOLOGY

Infotainment 25

Connectivity 26

Audio 30

Driver Assistance 32

Efficient Technologies 38

SAFETY

Safe and Secure 40

Lighting Technology 43

VERSATILITY

Truly Flexible 44

Business 46

Leisure 47

Towing 49

RANGE ROVER SPORT SVR

Performance and Design 51

Interior 52

SPECIFICATIONS

Choose Your Model 54

Choose Your Engine 64

Choose Your Exterior 66

Choose Your Wheels 74

Choose Your Interior 76

Choose Your Options and Land Rover Gear 82

THE WORLD OF LAND ROVER 90

YOUR PEACE OF MIND 93

Vehicle shown is Autobiography with Dynamic Pack in Firenze Red with optional features fitted (market dependent).

Vehicles shown are from the Land Rover global range. Specifications, options and availability will vary between markets and should be verified with your local Land Rover Retailer. CO₂ and fuel economy figures may vary according to wheel fitment and optional extras fitted.

INTRODUCTION

INTRODUCING RANGE ROVER SPORT

A muscular, powerfully planted stance and distinctive rearward sloping roof endow this vehicle with a truly sporting character. A dynamic look completed by the sleek wraparound LED headlights and Animated Directional Indicators.

Exceptional on-road performance and all-terrain capabilities elevate this vehicle into a class of its own. Exuding confidence, its sporty design is complemented by driving dynamics and seamlessly integrated technology. With a wide range of engines and a light aluminium monocoque body, it delivers a refined performance.

The efficient Plug-in Hybrid Electric Vehicle (PHEV) adds the benefits of a whisper-quiet electrified powertrain to these capabilities, creating a Range Rover Sport more relevant than ever to motoring today and in the future.

To ensure outstanding performance and great fuel efficiency, the new 360PS and 400PS 6-cylinder petrol engine incorporates Mild Hybrid Electric Vehicle (MHEV) technology. This system, along with other measures, also reduces CO₂ emissions and improves driveability.

Whilst the level of technology, including the Touch Pro Duo infotainment system, 12.3" Interactive Driver Display and full-colour Head-up Display, delivers an even more luxurious and engaging driving experience.

LIGHTING TECHNOLOGY

All-round exterior LED lighting is standard. Designed to last the lifetime of the vehicle, LED lights are more energy efficient and the quality of light produced is closer to daylight conditions, so driving at night becomes less tiring. Innovative Pixel-laser LED headlights provide the ultimate option and give the vehicle even greater presence. See page 41.

SEAMLESSLY INTEGRATED TECHNOLOGY

Touch Pro Duo has two 10" high-definition Touchscreens to ensure you stay connected and entertained. This is complemented by the 12.3" Interactive Driver Display with configurable touch steering wheel controls and our optional second generation full-colour Head-up Display. See page 25.

PERFORMANCE

A range of potent powertrains deliver breathtaking performance. The second generation 5.0 litre V8 Supercharged Petrol engine offers an improved output of 525PS and an even more powerful 575PS in SVR. See pages 62-63.

DRIVING DYNAMICS

The lightweight all-aluminium body helps deliver an unrivalled balance of agility, handling and refinement. A suite of precision-engineered technologies includes Dynamic Response and Electronic Active Differential with Torque Vectoring by Braking. See page 22.

COMPOSED TOWING

A towing capacity of up to 3,500kg, together with a choice of optional towing features - including an electrically deployable tow bar and Advanced Tow Assist - ensure New Range Rover Sport can handle the most demanding tasks. See page 47.

INTERIOR LUXURY

The meticulously designed, contemporary interior comes with enhanced comfort and wellbeing through optional Four-zone Climate Control and Cabin Air Ionisation. Semi-Aniline leather on Autobiography with Dynamic Pack provides even greater levels of luxury. See page 13.

DRIVER-FOCUSED COCKPIT

Designed around the driver, the signature cockpit feel of the front row seating is complemented by a range of intuitively placed features. These include the uncluttered console with SportShift Selector and gearshift paddles on the steering wheel. See page 13.



INTELLIGENT VERSATILITY

Innovative design features include flexible stowage options, such as the additional upper glovebox, the front centre console refrigerator compartment, flexible 5 + 2 seating and a range of charging options, including up to five USB ports, four 12V power sockets, and two domestic plug sockets. See pages 42-45.

SUPREME ALL-TERRAIN CAPABILITY

Intelligent AWD systems and a range of standard and optional all-terrain technologies, including Electronic Air Suspension, Terrain Response 2 and twin-speed transfer box with electronic centre differential, ensure an exceptional off-road performance. See pages 21-23.

INTRODUCING RANGE ROVER SPORT PLUG-IN HYBRID ELECTRIC VEHICLE¹

Capability, performance and cutting-edge technologies are at the heart of every Land Rover. Taking our vehicles into the future, electric power now propels us into an exciting new era. Our first ever Plug-in Hybrid Electric Vehicle (PHEV), is driven by our most innovative powertrain yet; an advanced Ingenium petrol engine and electric motor combine to give a dynamic and stylish ride with full Range Rover Sport capability¹. With a full electric charge, PHEV is capable of managing most city commutes. Drivers can select from two driving modes to best suit their needs. See pages 14-17 for details.

Parallel Hybrid Mode (The default driving mode) - Combined petrol and electric drive. When in Parallel Hybrid Mode, the driver can optimise battery charge or fuel economy by utilising two alternative charge management functions:

SAVE function - Prevents the battery charge dropping below the level which has been selected

Predictive Energy Optimisation (PEO) function - By entering a destination in the navigation system, the driver enables the feature, which utilises altitude data for the route selected to intelligently switch between the electric motor and petrol engine to maximise fuel economy

EV (Electric Vehicle) Mode - Full electric drive².

In addition to the benefits described above, an increasing number of major cities are introducing vehicle restrictions and charges from which drivers of PHEV vehicles could be exempt.

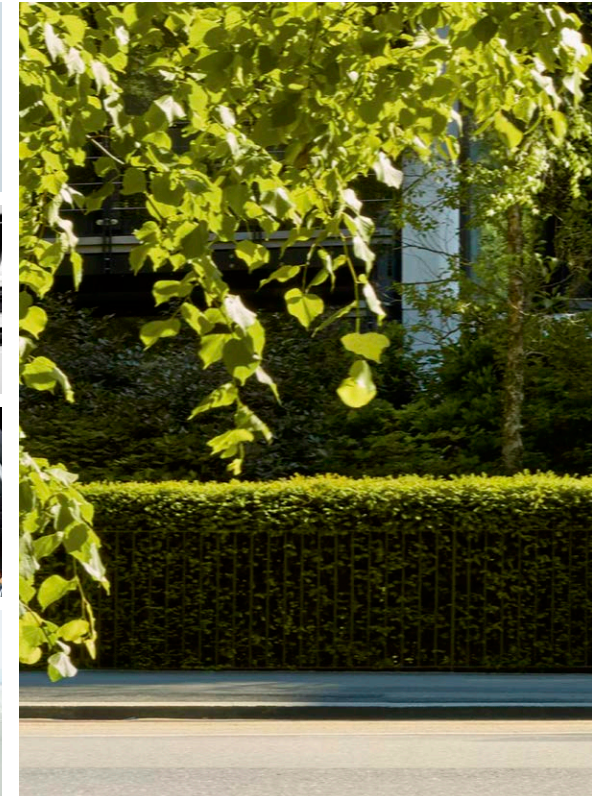

¹Please refer to the accompanying Technical Specification for full details on Driveline, Engine Performance and Fuel Economy. Note that CO₂ and fuel economy figures can vary according to wheel fitment, and the lowest figures may not be achievable with the standard wheels. ²Parallel Hybrid Mode will be automatically re-engaged should the driver require more power and torque than is available, or the battery charge drops to an insufficient level to maintain progress.

Rear loadspace capacity is reduced on P400e models, please see page 43 for more detail.

Engines, features and their availability may differ by vehicle specification and market. For full feature and option availability please refer to the online configurator or visit your local Land Rover Retailer.

Vehicle shown is Autobiography with Dynamic Pack and Bright Pack in Fuji White with optional features fitted (market dependent).

EV RANGE¹

PHEV is fully capable of managing most city commutes in full Electric Vehicle (EV) Mode¹.

EASY OVERNIGHT CHARGING

PHEV can fully charge from a domestic electricity supply in as little as 7.5 hours³, so it's ideally suited to charging at home overnight. See page 14.

CHARGING SOLUTIONS

A full charge can be achieved in as little as 2.75 hours³ at home using the accessory Universal charging cable and 32 amp industrial-type socket, or dedicated wall box. In addition, a range of charging points can be used at offices and other designated public places. See page 14.



REFINED DRIVE

Our quietest Range Rover Sport yet, PHEV delivers a virtually silent drive in full EV Mode. PHEV ensures seamless transition between the petrol engine and electric motor, delivering optimal refinement. See page 15.

NO COMPROMISE ON CAPABILITY AND PERFORMANCE

PHEV is precise and uncompromising. It is fully capable of handling off-road situations such as wading and rock crawl. Its on-road performance is equally remarkable, delivering additional power when you need it most through a combination of electric motor and petrol engine. See page 15.

LOW CO₂ EMISSIONS¹

PHEV's CO₂ emissions make it our lowest emission powertrain yet. See page 14.

SEAMLESS DESIGN

Integrating the charging port into the front grille provides easy connection without compromising the vehicle's dynamic design. See page 14.

³Charging times will vary by market, power supply and charging solution. Please refer to landrover-me.com for further information.

All in-car features should be used by drivers only when safe for them to do so. Drivers must ensure they are in full control of the vehicle at all times.



DESIGN

EXTERIOR

Muscular and perfectly proportioned, Range Rover Sport is designed to command attention wherever you take it. With its distinctive silhouette, rearward sloping roof and continuous waistline, Range Rover DNA is unmistakable throughout; its presence more formidable than ever. Every aspect of the vehicle has been designed with precision for immediate impact - its lower, sportier stance is enhanced by the revised front and rear bumpers with integrated exhaust finishers¹.

A cleaner, more dynamic design, there's a contemporary feel everywhere you look, from the Range Rover Sport grille, bonnet vents and fender vents to the refined, yet sporty wheel options such as 22" 9 split-spoke Gloss Dark Grey with contrast Diamond Turned finish. A dramatic, modern feel is completed by the wraparound LED headlights with front and rear Animated Directional Indicators². This powerful, athletic vehicle is now more compelling than ever.



¹Engine dependent. ²Animated Directional Indicators standard with Matrix LED, Pixel LED and Pixel-laser LED headlights.

Features and their availability may differ by vehicle specification and market. For full feature and option availability please refer to the online configurator or visit your local Land Rover Retailer.

Vehicle shown is Autobiography with Dynamic Pack in Firenze Red with Ebony/Vintage Tan interior with optional features fitted (market dependent).



INTERIOR

Luxurious, supremely comfortable and exceptionally functional, Range Rover Sport is a driver's vehicle through and through. The signature cockpit has been extensively reimagined; every element meticulously designed and beautifully executed. Intuitive controls include the SportShift Selector gear lever, providing the option of manual gear shifting, and flush touch-sensitive steering wheel switches.

The sense of luxury and innovation is reinforced by the revolutionary Touch Pro Duo technology, which incorporates two 10" Touchscreens as standard. The finest materials combine seamlessly with dynamic sports detailing such as the optional Extended Carbon Fibre veneer. The centrepiece is the bold intersection between the sportier horizontal elements of the instrument panel and the vertical lines of the centre console. The overall clean design is complemented by the enhanced optional Configurable Ambient Interior Lighting with a striking graphic light running the length of the console, and the uncluttered feel is maintained by flexible stowage solutions such as the additional upper glovebox.

The distinctive Sports Command Driving Position elevates the driver to provide a heightened sense of confidence and control, giving sweeping views over the road ahead. The seats can be specified in the finest Semi-Aniline leather with a Cut Diamond pattern in contemporary colourways - including Ebony Vintage Tan and Ebony Eclipse - to ensure this vehicle looks and feels as good as it drives.

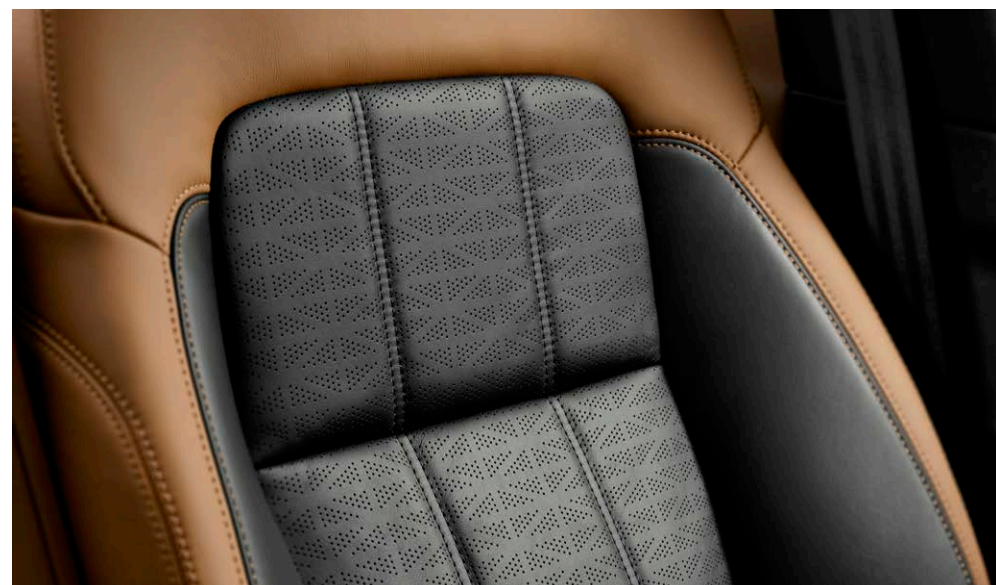
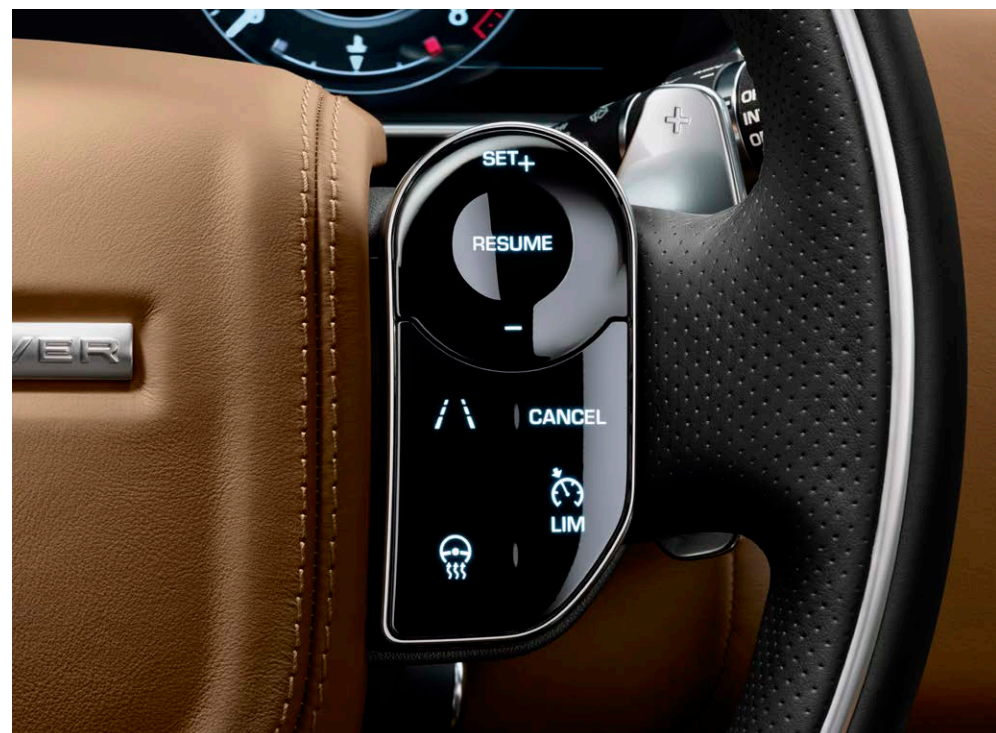

Features and their availability may differ by vehicle specification and market. For full feature and option availability please refer to the online configurator or visit your local Land Rover Retailer.

Interior shown is Autobiography with Dynamic Pack in Ebony/Vintage Tan with optional features fitted (market dependent).

PLUG-IN HYBRID ELECTRIC VEHICLE¹



Designed and engineered for an increasingly carbon-conscious world, our Plug-in Hybrid Electric Vehicle (PHEV), the P400e, delivers a dynamic driving experience with exceptional Range Rover Sport capability both on and off-road.

P400e uses the combination of an advanced 2.0 litre 300PS Si4 Ingenium Petrol engine supported by a high-capacity 140.8PS electric motor to deliver a combined output of 404PS. The electric motor can either supply its power in parallel with the engine, or drive the vehicle in the manually selectable Electric Vehicle (EV) Mode. The large 13kWh capacity battery gives the vehicle an all-electric range from a full charge, capable of managing most city commutes¹ with zero tailpipe emissions.

The P400e powertrain has been integrated seamlessly into the vehicle's design. The charging point is discreetly located in the front grille, which makes connection to a power supply both convenient and easy while lending itself to routine overnight home charging.

The battery can be fully charged in as little as 7.5 hours² using the home charging cable, supplied as standard. When rapid charging, a full charge can be achieved in as little as 2.75 hours² at home using a dedicated wall box or 32 amp industrial-type socket, or at a range of public charging points using a public charging cable. For charging away from home, the cable can be stored in the vehicle's loadspace using a purpose-designed storage case and retention system.

¹Please refer to the accompanying Technical Specification for full details on Driveline, Engine Performance and Fuel Economy. Note that CO₂ and fuel economy figures can vary according to wheel fitment, and the lowest figures may not be achievable with the standard wheels. ²Charging times will vary by market, power supply and charging solution.

Engines, features and their availability may differ by vehicle specification and market. For full feature and option availability please refer to the online configurator or visit your local Land Rover Retailer. Rear loadspace capacity is reduced on P400e models, please see page 43 for more details. Vehicle shown is Autobiography with Dynamic Pack and Bright Pack in Fuji White with optional features fitted (market dependent).

The P400e delivers an exceptionally refined experience. The electric motor can produce its maximum torque from standstill and delivers a virtually silent drive. If engine torque is required, the system uses the Integrated Starter Generator (ISG) for virtually instant starting, enabling engine torque to be perfectly blended with electric motor torque, smoothly delivering the driver's demand using the hybrid integrated transmission.

Off-road capabilities are uncompromised, and in some circumstances, enhanced. Unlike any other plug-in hybrid vehicle, P400e matches the 850mm wading depth³ of a Range Rover Sport fitted with a conventional engine, and the additional torque provided by the electric motor at low speed is an advantage in a variety of off-road situations.

The combination of the instant torque from the electric motor with that from the highly efficient direct injection petrol engine delivers a torque profile normally associated with large capacity petrol or diesel engines, providing exceptional on-road performance¹.

For extra convenience, the vehicle can be defrosted whilst charging and journeys can begin with the cabin pre-conditioned to a comfortable temperature. The supplementary heater and air conditioning compressor - both powered by the high-voltage battery - will pre-cool or pre-warm the vehicle without the requirement to start the engine when charging, or from the battery alone if sufficient charge is available.

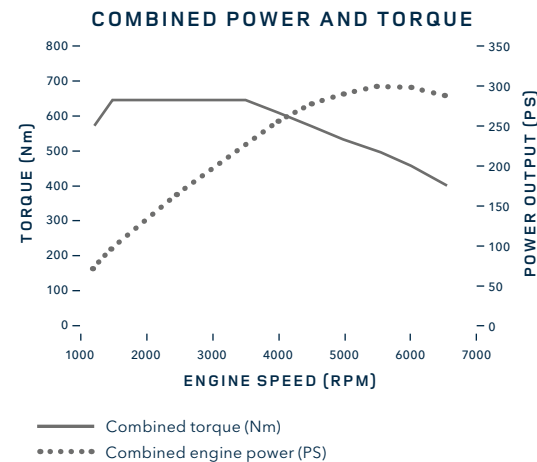

³Wading is only available when engine is engaged. Wading depth (25 degree entry and exit) 750mm, deep fording depth (9 degree entry and exit) 850mm.

Vehicles shown are from the Land Rover global range. Specifications, options and availability will vary between markets and should be verified with your local Land Rover Retailer.

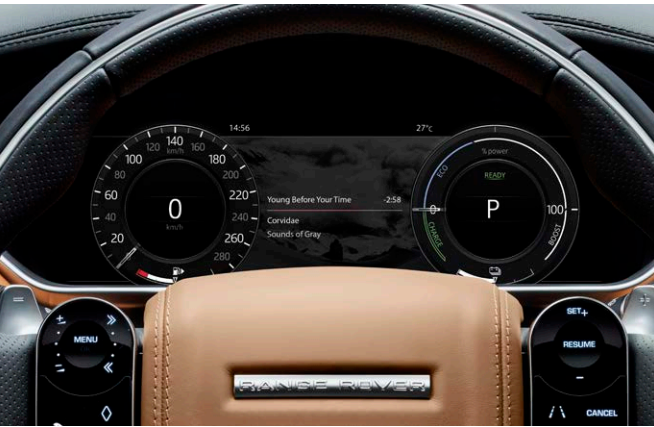

PLUG-IN HYBRID ELECTRIC VEHICLE*

In Parallel Hybrid Mode (the default driving mode), the electric motor supplies its power in parallel with the engine. There is a seamless transition between the 140.8PS electric motor and the Si4 Ingenium Petrol engine, as the system smoothly starts the engine and then blends electric motor and petrol engine power together, using the hybrid integrated transmission. Intelligent battery management, which charges the battery through regenerative braking and even when the vehicle is coasting, ensures P400e always has sufficient charge to provide 404PS power output, to deliver seamlessly impressive performance when required.

When in the default driving mode (Parallel Hybrid), the driver can optimise fuel economy or battery charge by utilising one of two alternative charge management functions:

SAVE function - Manually selected through the Touchscreen, SAVE function prevents the battery charge dropping below the level which has been selected. This allows the driver to provision for quiet, zero-emission travel at a later point in the journey. The vehicle will only use the electric motor if the battery has received a charge over and above the saved level through regenerative braking.

Predictive Energy Optimisation (PEO) function - Entering a destination in the vehicle's navigation system will automatically engage the PEO function. By utilising altitude data for the chosen route, PEO intelligently switches between the electric motor and petrol engine to maximise fuel economy throughout the journey.

In addition to operating as a parallel hybrid, the large capacity battery enables the driver to operate the vehicle in **EV (Electric Vehicle) Mode**. Manually selected by a button on the console, EV Mode enables the vehicle to run solely on the electric motor using the energy stored in the battery, the ideal solution for quiet, zero-emission journeys. The system will introduce the petrol engine should the driver require more power than is available through the electric motor alone, or if the battery charge drops to an insufficient level to maintain progress.

*Please refer to the accompanying Technical Specification for full details on Driveline, Engine Performance and Fuel Economy. Note that CO₂ and fuel economy figures can vary according to wheel fitment, and the lowest figures may not be achievable with the standard wheels.

1 140.8PS ELECTRIC MOTOR

PHEV features a high-power 140.8PS permanent magnet synchronous electric motor to deliver power effortlessly.

2 INTEGRATED HYBRID AUTOMATIC TRANSMISSION

A seamless transition from EV to Internal Combustion Engine (ICE) is delivered via the hybrid integrated transmission.

3 2.0 LITRE INGENIUM ENGINE

Developed and engineered by Jaguar Land Rover, our aluminium 2.0 litre 300PS Si4 Ingenium Petrol engine is lighter and more efficient than predecessors.

4 13KWH HIGH-VOLTAGE BATTERY

The large capacity battery gives the vehicle an all-electric range, capable of managing most city commutes* from a full charge.

5 7KW ONBOARD CHARGER

The powerful 7kW onboard charger can deliver a full battery charge in as little as 2.75 hours, dependent on charging station capability.

6 INTEGRATED STARTER GENERATOR

The Integrated Starter Generator (ISG) delivers an exceptionally refined starting of the petrol engine when required.

7 REGENERATIVE BRAKING

Regenerative braking uses the electric motor to harvest kinetic energy whilst braking, converting it to electrical energy that is used to recharge the high-voltage battery.

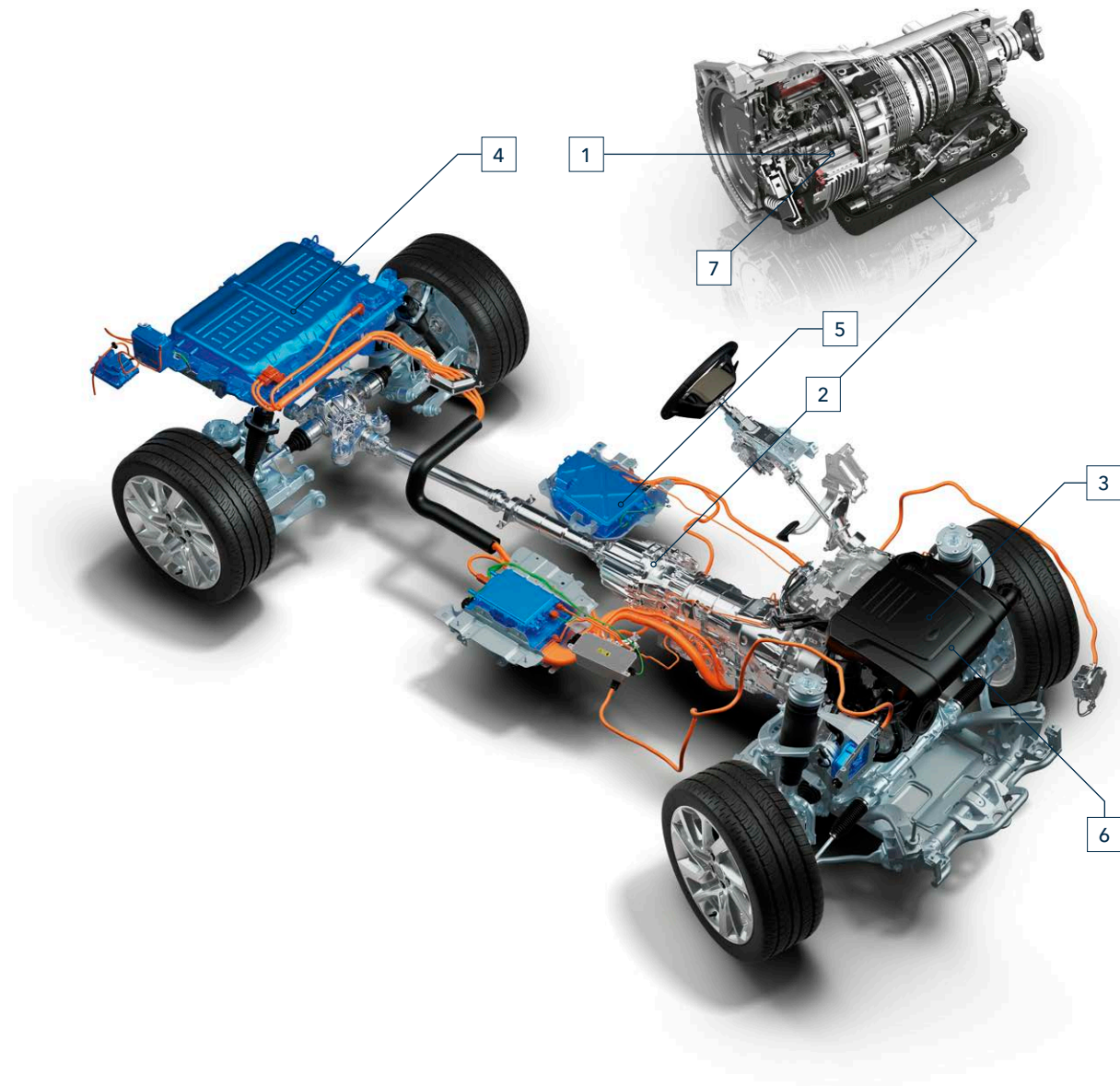

PERFORMANCE AND CAPABILITY

ENGINES AND TRANSMISSION

From power and sheer driving pleasure to fuel economy and refinement, there is a range of engines available for Range Rover Sport, and each has been optimised for specific attributes to cater for all needs. All engines are equipped with Stop/Start technology and smart regenerative charging (except P400e); this feature prioritises the charging of the battery when the vehicle is decelerating to capture wasted kinetic energy and reduce fuel consumption for maximum economy, especially during urban driving.

Ingenium technology underpins the 4 and 6-cylinder petrol engines in the Range Rover Sport range. These low-friction, all-aluminium engines have stiff cylinder blocks and twin balancer shafts to ensure inherently low levels of vibration, enabling a smooth and refined driving experience. For engine availability see pages 62-63.

8-SPEED AUTOMATIC TRANSMISSION

All engines in Range Rover Sport are coupled with an 8-speed Automatic Transmission. With eight closely spaced ratios, the transmission ensures that you are always in the optimum gear, maximising fuel efficiency and acceleration. Gear changes are almost imperceptible and shift schedules intelligently adapt to your driving style.

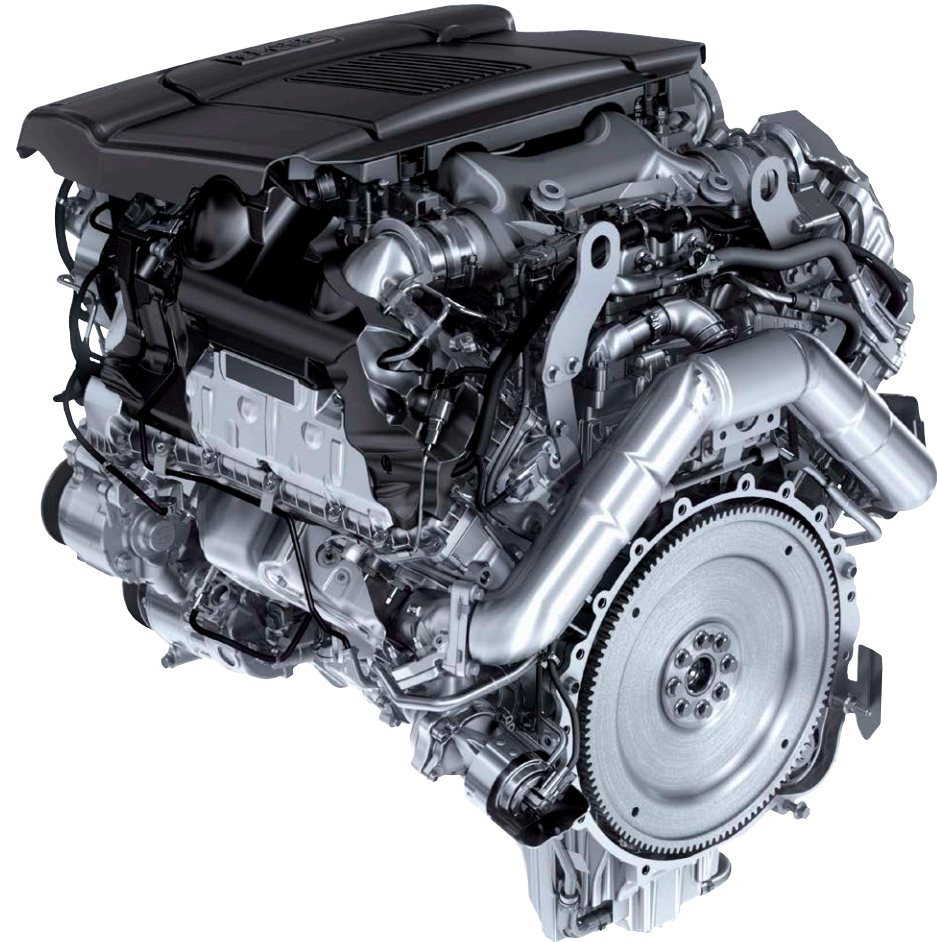

MILD HYBRID ELECTRIC VEHICLE

Land Rover is at the forefront of sustainable innovation. Taking our vehicles into a smarter and more exciting future, Mild Hybrid Electric Vehicle (MHEV) technology is a system that uses a belt-driven starter generator and state-of-the-art 48V battery. These harvest energy that would normally be lost during deceleration, which is then intelligently redeployed.

The stored electricity can be used by the starter generator to provide torque assistance to the engine directly, or to power the electric Supercharger to boost performance before the conventional Turbocharger reaches its maximum output, giving seamless throttle response. This system helps improve fuel economy and boosts the vehicle's performance. The combination of MHEV technology, together with other detailed efficiency improvements, lowers the CO₂ emissions of the Ingenium inline 6-cylinder engines substantially, when compared to the outgoing engine.

The MHEV technology is standard with P360 and P400 engines. Vehicles with the P400 engine also feature Terrain Response with Dynamic Program and Configurable Dynamics, as standard. These features allow personalisation of the vehicle's dynamic settings, complementing the performance characteristics of the engine.

- 1 48V ELECTRIC SUPERCHARGER
- 2 TWIN-SCROLL TURBOCHARGER
- 3 48V LITHIUM-ION BATTERY
- 4 BELT-DRIVEN INTEGRATED STARTER GENERATOR
- 5 48V/12V DC-DC CONVERTER
- 6 12V BATTERY

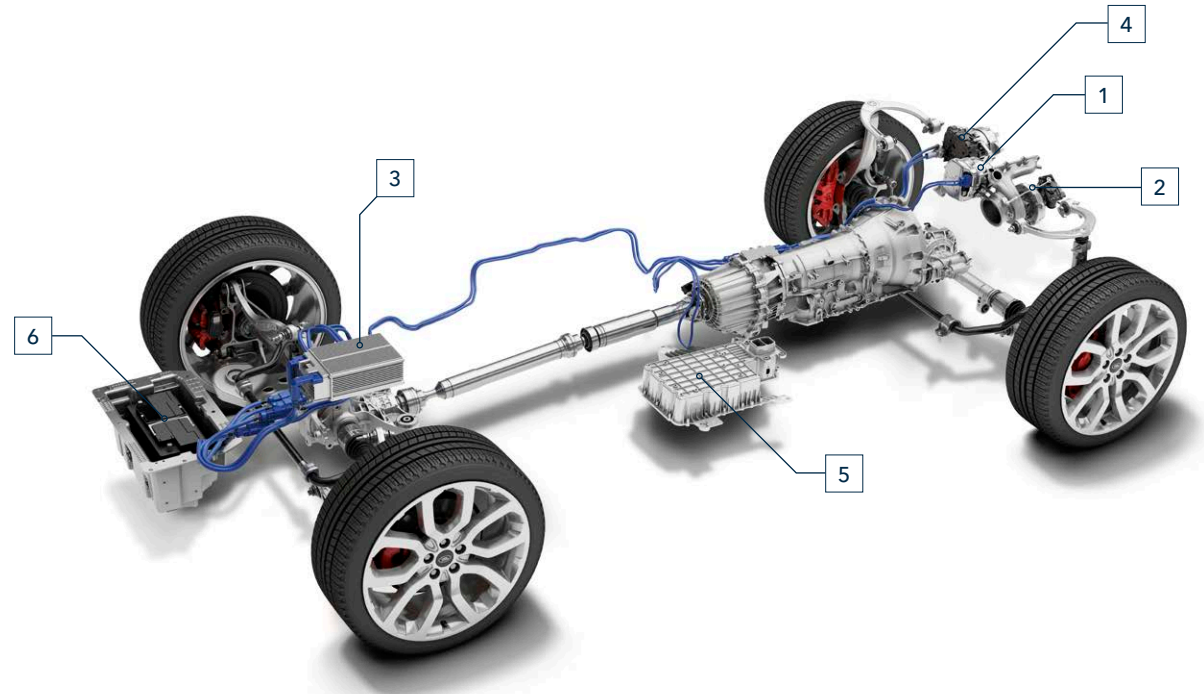



LEGENDARY BREADTH OF CAPABILITY

Range Rover Sport continues to offer outstanding capability on and off-road, with permanent All Wheel Drive (AWD) and Land Rover's revolutionary Terrain Response system fitted as standard - which means this capability can be harnessed by all drivers, expert and inexpert alike. This extraordinary capability can be extended to suit individual requirements with a range of additional, optional all-terrain technologies.

ELECTRONIC AIR SUSPENSION

A sure-footed, composed drive is completed by the latest Electronic Air Suspension provided as standard, which provides exceptional wheel articulation and poise. It changes the vehicle's height quickly, allowing cross linking of the diagonal wheels to keep all four wheels on the ground on very uneven surfaces. Added to which, it makes loading heavy objects into the boot easier, as you can lower the vehicle's rear suspension height by up to 50mm to suit your needs. These functions can be operated via the 10" Touchscreen, a button in the loadspace area or remotely via the key fob.

The Speed Lowering system uses the Electronic Air Suspension to reduce aerodynamic drag and fuel consumption at cruising speeds, by lowering the vehicle by 15mm from normal ride height when the speed reaches 105km/h.

TWIN-SPEED TRANSFER BOX WITH ELECTRONIC CENTRE DIFFERENTIAL

An additional set of lower gears can prove invaluable in challenging conditions such as steep inclines or declines, off-road driving or when towing. The optional twin-speed transfer box system gives you precise speed and control in such instances. The heart of the twin-speed system is the electronic centre differential that offers a 50:50 torque split between front and rear axles, with the ability to pre-emptively lock the axles before slip commences.



TERRAIN RESPONSE

When you manually select Land Rover's unique standard Terrain Response system, it sets the vehicle up optimally to match the demands of the terrain, by adapting the responses of the vehicle's engine, gearbox, differentials and chassis systems. There are five manual Terrain Response settings: Comfort, Grass/Gravel/Snow, Mud and Ruts, Sand, and Eco Mode.

TERRAIN RESPONSE 2

Terrain Response 2 is an option that takes the capabilities of the award-winning system to a new level. This features an automatic setting which monitors the current driving conditions and systematically selects the most suitable terrain setting. It also includes additional Rock Crawl Mode. An additional setting is available when **Terrain Response 2 with Dynamic Program** is specified. Dynamic Program tunes the suspension to deliver even tighter body control with flatter handling and sharper responses. You can manually override the system should you wish.



ADAPTIVE DYNAMICS

Adaptive Dynamics¹ makes the miles go by virtually unnoticed. The system monitors vehicle movements up to 500 times a second, reacting to driver or road inputs almost instantaneously, to give greater control and minimise body movement, ensuring a composed, flat ride. The system even senses off-road conditions, and optimises damping accordingly so driver and passengers arrive at their destination refreshed and relaxed.

CONFIGURABLE DYNAMICS

To enhance either refinement and comfort or the vehicle's performance, the Configurable Dynamics² function allows you to configure Range Rover Sport's throttle mapping, gearbox shift points, steering settings and suspension to suit your particular driving needs.

ELECTRONIC ACTIVE DIFFERENTIAL WITH TORQUE VECTORING BY BRAKING

The Torque Vectoring by Braking system³ delivers responsive, controlled cornering and handling through even the tightest of bends. The Electronic Active Differential and vehicle's braking system constantly balance the distribution of engine torque between the four wheels when cornering.

Exceptional grip and steering confirm Range Rover Sport as our most dynamic SUV.

The system is also active in off-road conditions using the relevant Terrain Response settings. It can be very effective in conditions such as sand, where it helps the vehicle turn in and avoid excessive understeer.

DYNAMIC RESPONSE

Dynamic Response³ improves vehicle handling through hydraulic roll control, optimising on-road performance and passenger comfort, by reducing the amount of body lean during cornering.

By controlling the front and rear axles independently, it can deliver increased low-speed agility, along with enhanced high-speed stability and greater steering precision.

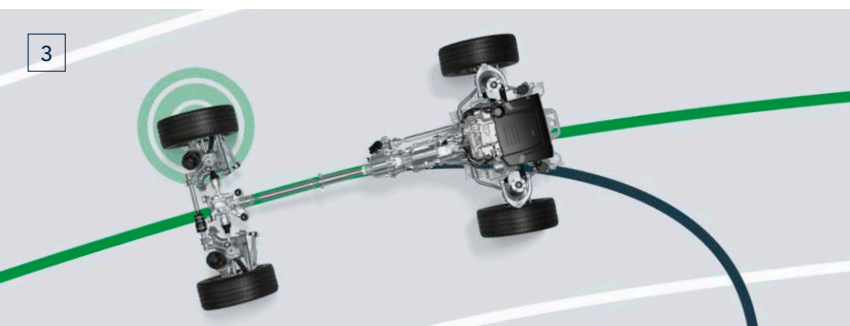
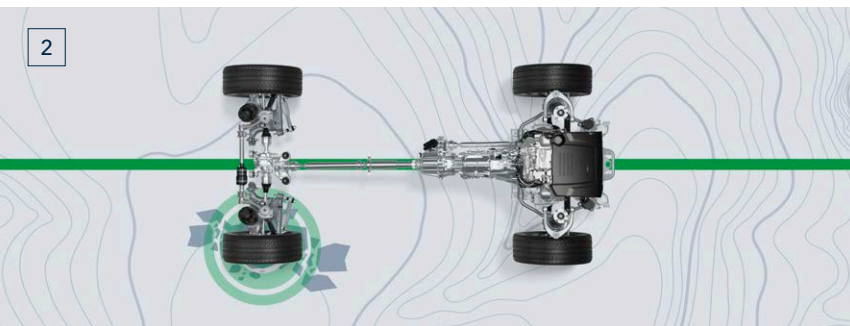
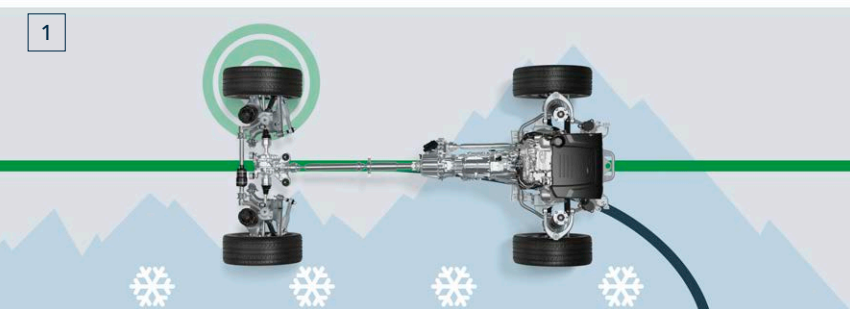

1 SAFETY

2 ULTIMATE CAPABILITY

3 COMPOSURE

ALL TERRAIN PROGRESS CONTROL

All Terrain Progress Control (ATPC) is a state-of-the-art system that enables you to set and maintain a steady speed in challenging conditions such as slippery surfaces, including mud, wet grass, ice, snow and dirt roads. Operating like a cruise control system, it functions at low speed between 1.8km/h and 30km/h, enabling you to maintain full concentration on steering and finding a path through obstacles.

LOW TRACTION LAUNCH

Providing you with optimum torque control when you move off from a standstill, Low Traction Launch can be activated from the Touchscreen and enhances capability in slippery conditions like wet grass, snow and ice.

HILL DESCENT CONTROL

Land Rover's patented Hill Descent Control (HDC) is a standard feature. It assists the driver with controlled descents of difficult slopes. It does so by maintaining a constant speed and applying braking separately to each wheel.

WADE SENSING

Unique to Land Rover, this optional system uses ultrasonic sensors in the wing mirrors to visually and audibly alert the driver if the water approaches the vehicle's class-leading wading depth of up to 850mm. It does so by providing real-time pictorial information via the Touchscreen about its depth in relation to the vehicle and its maximum wading capability. Only available with 360° Surround Camera.



Features and their availability may differ by vehicle specification and market. For full feature and option availability please refer to the online configurator or visit your local Land Rover Retailer.

Vehicle shown is Autobiography with Dynamic Pack in Firenze Red with optional features fitted (market dependent).



INFOTAINMENT

Delivering a wealth of information and entertainment, every Range Rover Sport is equipped with our InControl infotainment system, Touch Pro Duo. It features intuitive and advanced integrated technologies to ensure everyone can make the most of their journey.



TOUCH PRO DUO

The standard 10" dual high-definition Touchscreens allow the user to view required information whilst simultaneously being able to interact with additional features, for increased flexibility and efficiency of use. For instance, you can use the navigation system in the upper screen whilst adjusting multimedia settings on the lower. Direct access to cabin and seat temperature controls are also available via the multi-function Dynamic Dials. For a truly elegant and streamlined appearance, the steering wheel also has hidden-until-lit, touch-sensitive switches as standard. One of these switches is programmable, so that it can be personalised to your preferences to accomplish a host of functions.



INTERACTIVE DRIVER DISPLAY

The 12.3" high-definition Interactive Driver Display can receive and project a vast amount of driving information, entertainment and active safety data including navigation, phone and media. Its high resolution ensures the utmost clarity, and its refined processing engine delivers smooth-moving, pin-sharp graphics. Features can be accessed on either the Interactive Driver Display or the Touch Pro Duo Touchscreens.



HEAD-UP DISPLAY

Without distraction or the need for you to take your eyes off the road, Head-up Display¹ is an option that presents key vehicle data such as your speed, gear position and navigation directions on the windscreen. It features crystal-clear, full-colour graphics in high resolution, enabling you to see all driver inputs and information with ease, including phone/call status. The feature can be turned on and off dependent on driver preference.



REAR SEAT ENTERTAINMENT

The optional Rear Seat Entertainment system provides two 8" screens built into the rear of the front headrests or two 10" high-definition seat mounted articulating Touchscreens. It includes 'Journey Status', a navigation summary screen which displays a pop-up for the rear occupant detailing the time and distance to destination. Both systems come with a pair of WhiteFire[®] digital wireless headphones and HDMI, Mobile High-definition Link (MHL), CD/DVD player and USB connections. Passengers can also enjoy their favourite TV shows via the optional Digital TV² feature.

¹For optimal performance, solar attenuating glass may be required. Please consult your Land Rover Retailer for further information. ²Market dependent. WhiteFire[®] is a registered trademark of Unwired Technology LLC and any use of such marks by Land Rover is under licence. All in-car features should be used by drivers only when safe for them to do so. Drivers must ensure they are in full control of the vehicle at all times.

CONNECTIVITY

InControl is Land Rover's suite of standard and optional features that connects you to your vehicle and links you seamlessly, and securely, with the outside world. With a selection of apps, even when you're away from your vehicle some of the InControl features stay with you, making sure the Land Rover experience is more enjoyable than ever.

STANDARD FEATURES

VOICE RECOGNITION SYSTEM

So you can complete tasks without taking your eyes off the road, Range Rover Sport offers intelligent voice recognition. For example, 'tune to 97.9' or 'call home'.

NAVIGATION PRO

Navigation Pro allows you to save your favourite places, use swipe and pinch-to-zoom gestures for simple map exploration and can display a choice of either 2D or 3D crystal-clear map graphics. Navigation Pro functionality is further enhanced by Connect Pro.

OPTIONAL FEATURES

CONNECT PRO*

Connect Pro consists of Remote Premium and Pro Services with 4G Wi-Fi Hotspot, and is designed to enhance your in-car and out-of-car experience, ensuring you and your passengers enjoy the journey whilst remaining connected to the world.

Pro Services include:

- **Real Time Traffic Information** - Uses live traffic data feeds to give you the most accurate picture of what the traffic is like on the way to your destination.
- **Online Search** - Wherever you are, you can search the surrounding area for places of interest. The system can access expert destination information, travel tips and inspiration, as well as online travel reviews of the local area.
- **Planning Routes and Door-to-Door Routing** - Before setting off, use the optional Route Planner app or go online to search, save locations or set your destination. The app uses the Cloud to send your destination automatically to your vehicle's navigation screen. Once you've parked, the Route Planner app will guide you to your destination
 - a true door-to-door experience which includes public transport options.
- **Share ETA** - You can share your estimated time of arrival so your selected contact(s) will know exactly when you will arrive, as calculated by the navigation guidance system. If you're running late, Share ETA can then send automatic updates via text messages or email, without any further action from you.
- **Satellite View** - When you want to get the context of your surroundings from overhead, simply switch to satellite view.

*Connect Pro require a SIM with a suitable data contract. Online functionality and Wi-Fi connectivity is dependent on the installation of a micro SIM with a suitable data contract. InControl features, options and their availability remain market dependent - check with your Land Rover Retailer for local market availability and full terms.

Information and images displayed in relation to the InControl technology, including screens or sequences, are subject to software updates, version control and other system/visual changes depending on options selected. Mobile network connectivity cannot be guaranteed in all locations. InControl Apps will need to be downloaded from the Apple/Play Store. All in-car features should be used by drivers only when safe for them to do so. Drivers must ensure they are in full control of the vehicle at all times.

Features and their availability may differ by vehicle specification and market. For full feature and option availability please refer to the online configurator or visit your local Land Rover Retailer.

- **Commuter Mode** - Allows the system to learn your commutes and automatically advises you of the expected journey time based on live and historical traffic movements, without you having to input a destination. The system learns the routes you take for a given destination and then advises which of those is the quickest. The feature can be turned on and off dependent on driver preference.
- **Online Routing** - While you're on your way to a destination, the system monitors live traffic conditions and takes into account typical traffic patterns for that time of day, keeping you on the optimum route.

SMARTPHONE PACK

By screen sharing with Range Rover Sport's InControl infotainment system, the Smartphone Pack helps you stay safely connected to your smartphone even while in the car. Applications include:

- **Apple CarPlay®** is also designed for increased safety, enabling the use of apps while allowing the driver to concentrate on the road ahead. Connect your Apple smartphone to your car to use compatible apps such as maps, messages and music through the Touchscreen.

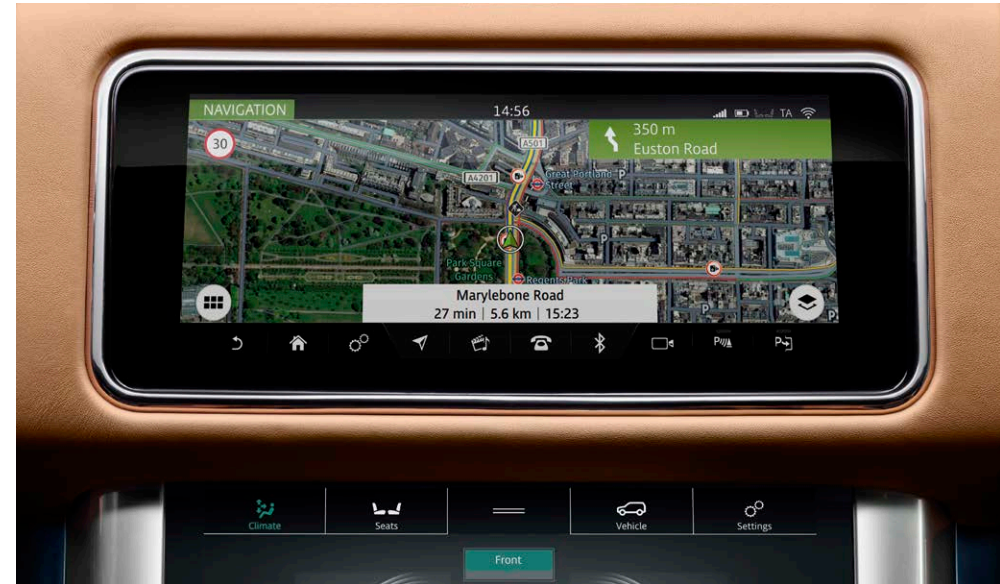

AUDIO

A vehicle's cabin is the ideal place within which to experience your personal choice of music, and Range Rover Sport has the option of four different audio systems to bring your music to life:

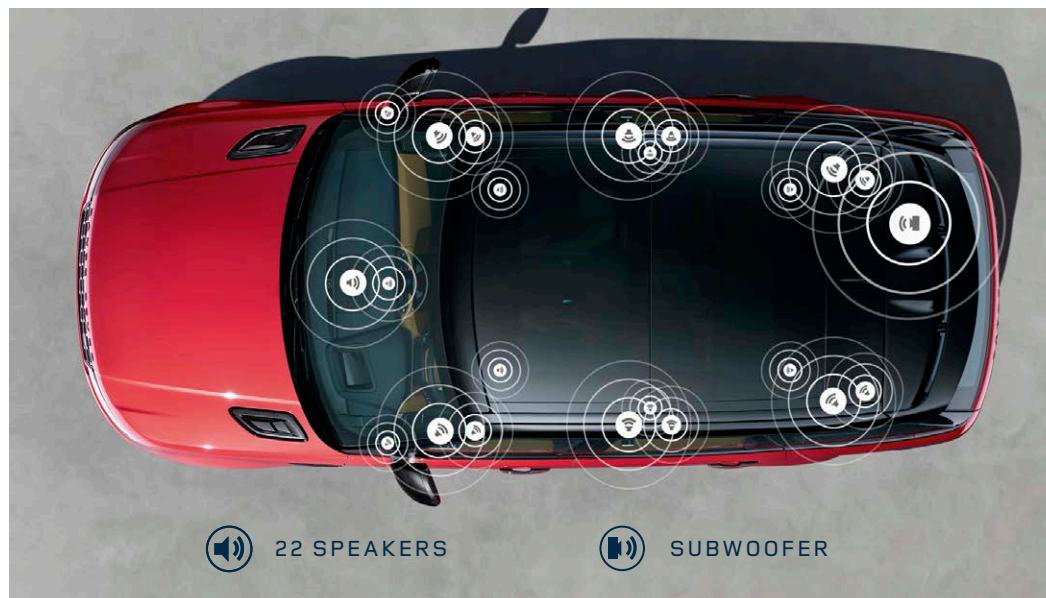

Meridian™ Signature Sound System with 22 speakers and a dual channel subwoofer.

ENHANCED SOUND SYSTEM

Outstanding acoustic range through eight speakers.

MERIDIAN™ SOUND SYSTEM

Great definition, crystal-clear highs and full, deep bass – delivered through the careful arrangement of 12 speakers and a dual-channel subwoofer.

MERIDIAN SURROUND SOUND SYSTEM

All the fullness and clarity of a live performance delivered through an arrangement of 18 speakers and a dual-channel subwoofer – seamlessly brought together using Trifield™ technology. Exclusive to Meridian, Trifield perfectly blends the centre and surround channels with left and right channels ensuring an optimum, consistent sound experience for each passenger.

MERIDIAN SIGNATURE SOUND SYSTEM

This delivers truly life-like reproduction, creating a profound, personal sound experience for every seat. World-first Trifield 3D technology takes surround sound to the next level – the Signature Sound System includes 22 speakers and a dual-channel subwoofer. Incredibly authentic, the sense of cabin space is expanded to a 3D experience – rendering all the instruments, performers and venues of your favourite performances in true scale and location.

MODEL AVAILABILITY	SE	HSE	HSE WITH DYNAMIC PACK	AUTOBIOGRAPHY WITH DYNAMIC PACK	SVR
Enhanced Sound System	■	■	■	-	-
Meridian™ Sound System	□ ¹	□ ¹	□	-	-
Meridian™ Surround Sound System	□ ³	□ ³	□	■	■
Meridian™ Signature Sound System	-	□ ²	□	□	□

■ Standard □ Optional - Not Available.

¹Meridian Sound System is not available with Si4 engines. ²Meridian Signature Sound System is not available with Si4 engines. ³Meridian Surround Sound System is standard with P400e.

Features and their availability may differ by vehicle specification and market. For full feature and option availability please refer to the online configurator or visit your local Land Rover Retailer.

MERIDIAN™

Formed in 1977 in Cambridgeshire, England, Land Rover’s audio partner Meridian has pioneered many firsts, including active speakers and the world’s first digital surround sound processor.

Meridian’s audio technology input has helped ensure that Range Rover Sport is the most superb space within which to experience sound. Meridian Cabin Correction technology was utilised to analyse cabin shape, acoustics and resonance characteristics in order to help remove unwanted sounds.

The advanced algorithm ensures that the rhythm, punch and timing of any piece of music are heard precisely how the artist intended, providing a consistently exceptional quality audio experience for all passengers in the vehicle.



DIGITAL SIGNAL PROCESSING

Brings all elements of the audio system together as one, for performance that would otherwise require significantly larger speakers.



MERIDIAN CABIN CORRECTION

The advanced algorithm of Meridian’s Cabin Correction tailors the sound experience to the precise acoustics of Range Rover Sport’s interior.



MERIDIAN DIGITAL DITHER SHAPING

To maintain the quality of musical recordings, they are converted into a common digital format. Meridian Digital Dither Shaping ensures that digital signal conversions are made smoothly and seamlessly, preserving the finest details of the audio performance. The result is authentic musical conversion, evoking the emotions of the original recording.













TRIFIELD™

Exclusive to Meridian, Trifield blends the centre and surround channels seamlessly with the left and right, delivering a consistent, concert-like experience for all occupants.



TRIFIELD 3D

Building on Meridian’s proven Trifield surround sound technology, world-first in-car Trifield 3D truly brings musical performances to life. Through the addition of dedicated height channels, the sense of cabin space is expanded to a 3D experience, for a supreme sense of scale and definition to your music.

	UNIQUE MERIDIAN TECHNOLOGY	SPEAKERS	WATTS
ENHANCED SOUND	N/A	8	250
MERIDIAN™ SOUND	  	13	380
MERIDIAN™ SURROUND SOUND	   	19	825
MERIDIAN™ SIGNATURE SOUND	   	23	1,700

Meridian is a registered trademark of Meridian Audio Ltd.
Trifield and the three fields device is a trademark of Trifield Productions Ltd.
Features and their availability may differ by vehicle specification and market.

DRIVER ASSISTANCE

MAKING DRIVING EASIER

From negotiating city traffic or the motorway, to providing additional safety for you and your passengers, there's a wealth of innovative technologies available; either as standard, optional or as part of an optional pack. Whichever you choose, you'll find every single feature has been designed and engineered to heighten your enjoyment of the vehicle.

STANDARD DRIVE FEATURES



Lane Departure Warning

- **Cruise Control and Speed Limiter** allows the driver to maintain the current speed of the vehicle without the need for continued use of the accelerator pedal, helping to reduce driver fatigue. The Speed Limiter will also allow the driver to preset a maximum specified speed that the vehicle will not exceed. Both functions can be easily turned on or off by the driver as desired.
- **Lane Departure Warning** can help make long journeys much safer. The system senses when your vehicle is unintentionally drifting out of your lane, and notifies you with a visual alert and a gentle vibration of the steering wheel.

OPTIONAL DRIVE FEATURES



High-speed Emergency Braking

- **Adaptive Cruise Control** will keep your vehicle a safe distance from the one in front, should it slow or stop when you're cruising on the motorway or travelling in slow-moving traffic. Should the vehicle in front stop completely, your vehicle will come to a smooth halt. In stop-start traffic, Adaptive Cruise Control will automatically resume following the car in front. The system can be activated from 20km/h and once activated will operate between 0-200km/h.
- **High-speed Emergency Braking** detects when a potential frontal collision with another vehicle may occur and displays a forward alert to warn the driver to brake. If the driver doesn't react, the vehicle will deploy the brakes in order to reduce the severity of the possible impact. High-speed Emergency Braking is ready and active from 10km/h to 160km/h.

OPTIONAL DRIVE PACKS

DRIVE PACK



Blind Spot Monitor

The optional Drive Pack offers a range of features that help keep you safe and informed. The Drive Pack includes:

- **Driver Condition Monitor** detects if you're starting to feel drowsy and gives you an early warning when you need to take a break.
- **Blind Spot Monitor** alerts you to vehicles in, or quickly approaching, your blind spot. When a vehicle is detected, a small warning light will illuminate in the corresponding wing mirror. If you indicate in the direction of the obstacle, the warning light will flash to highlight potential danger.

DRIVE PRO PACK



Adaptive Cruise Control

For an even more relaxed drive, the optional Drive Pro Pack contains a wide range of driver assistance features including the Driver Condition Monitor in the Drive Pack, plus:

- **Lane Keep Assist** detects when your vehicle is unintentionally drifting out of your lane, and gently applies a corrective torque to the steering wheel, encouraging you to guide your vehicle back.
- **Blind Spot Assist** can help prevent collisions. If your vehicle detects another car in your blind spot when you begin to change lanes, a small warning light illuminates in the corresponding wing mirror and a steering torque encourages you to guide your vehicle away from the approaching vehicle.
- **Adaptive Cruise Control** - See page 30 for description.
- **High-speed Emergency Braking** - See page 30 for description.

ENJOY STRESS-FREE PARKING

Range Rover Sport offers the most advanced technologies to deliver intuitive and easy parking solutions. Whether reversing, parallel parking or getting into or out of tight spaces, these features make life easier. Available as standard, optional or as part of an optional pack.

STANDARD PARK FEATURES



Front and Rear Parking Aid

- **Front and Rear Parking Aid** helps make manoeuvring even easier. When you select Reverse, or choose to activate them manually, sensors located in the front and rear bumpers are triggered. As you park, the Touchscreen display and audio feedback indicates how close you are to obstacles.
- **Rear Camera** provides improved visibility when reversing. Static lines representing the vehicle's outer perimeter and predicted path are superimposed on the rearward image, to make parking in tight spots as easy as possible. This valuable parking aid also helps when hitching a trailer.

OPTIONAL PARK FEATURES



360° Surround Camera

- **360° Surround Camera** uses four digital cameras discretely placed around the vehicle, providing a 360° overhead view on the Touchscreen. With the capacity to display several different views at the same time, this helps with various manoeuvres from parking by a kerb, to getting in and out of tight spaces and junctions.

OPTIONAL PARK PACKS

PARK PACK



360° Parking Aid

The optional Park Pack assists you with manoeuvring in tight spaces and in urban environments, it features:

- **360° Parking Aid** gives you complete confidence when manoeuvring in tight spaces. Sensors located around the vehicle are automatically triggered when Reverse is selected, or can be manually activated, with a graphic appearing on the Touchscreen showing an overhead view of the vehicle. As you park, the Touchscreen display and audio feedback indicates how close you are to obstacles.
- **Rear Traffic Monitor** is particularly useful when reversing out of a parking bay. The system warns you of vehicles, pedestrians or other hazards approaching from either side of your vehicle. It will alert you with both audio and visual warnings, so you know what's behind you even when the view is obstructed.
- **Clear Exit Monitor** alerts rear passengers to any approaching cars, cyclists or other hazards before they leave the vehicle. As the rear seat passenger pulls the door handle to leave your vehicle, a warning light will flash on the rear door if an incoming obstacle is detected.

PARK PRO PACK



Park Assist

The optional Park Pro Pack enables you to park and manoeuvre safely and securely in and out of tight spaces, and into traffic that is obscured by buildings or other vehicles. It includes the 360° Parking Aid, Rear Traffic Monitor and Clear Exit Monitor in the Park Pack, plus:

- **Park Assist** makes parallel and perpendicular parking easier than ever, by steering your vehicle into a suitable space. You just have to select the appropriate gear and control the vehicle's speed with the brake and accelerator pedals. Graphics and notifications guide you through the manoeuvres. Park Assist will also steer you out of a space, taking all of the stress out of parking.

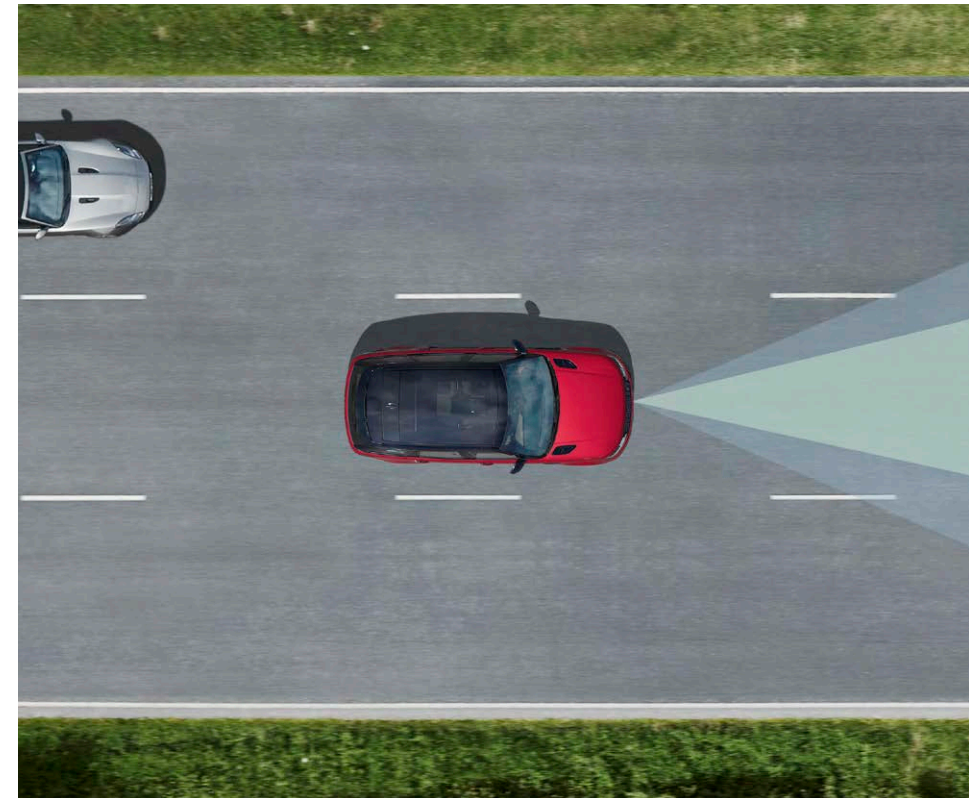



FRONT CAMERA

FRONT RADAR

DRIVER ASSIST PACK

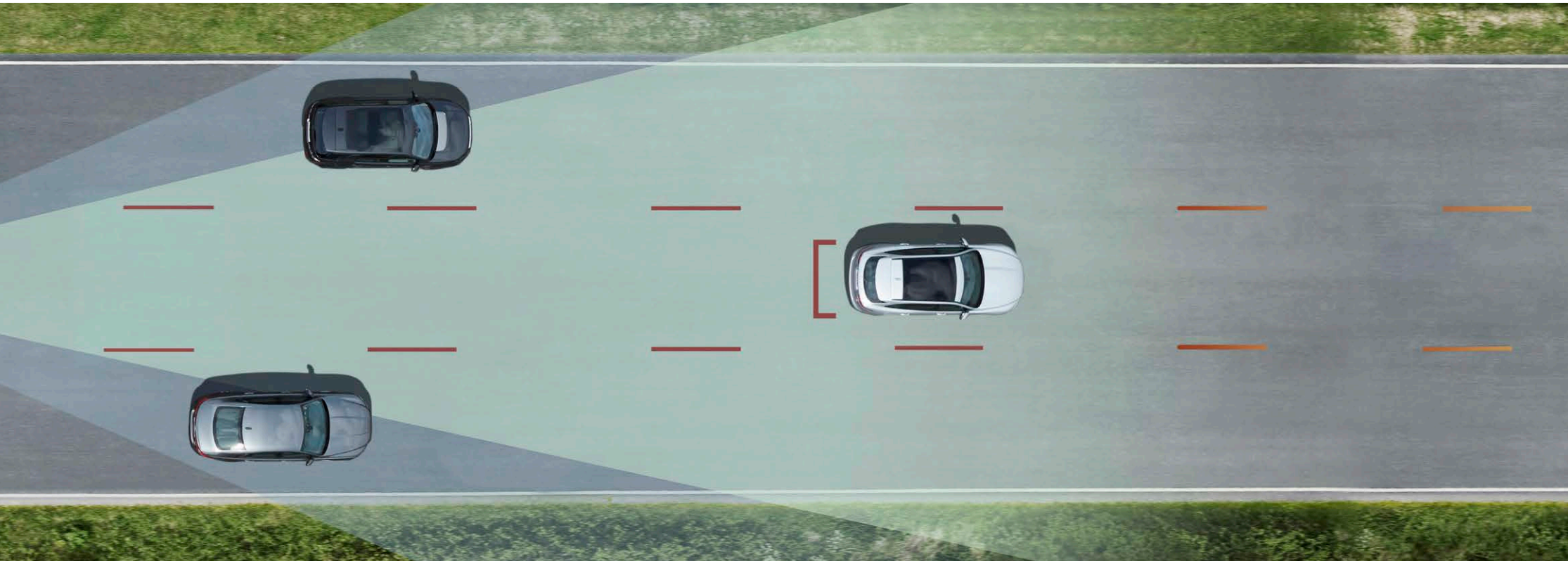
The optional Driver Assist Pack offers a wide range of driver aids including the features found in the Drive Pro Pack (see page 31), the Park Pro Pack (see page 33) and the 360° Surround Camera. It also includes Adaptive Cruise Control with Steering Assist. This latest technology makes motorway driving and heavy traffic situations even easier and more comfortable. It achieves this by gently assisting steering, acceleration and braking to centre the vehicle in lane while maintaining a set distance from vehicles ahead. Moderate steering interventions ensure that the physical effort of maintaining a central vehicle position is reduced.



ADAPTIVE CRUISE CONTROL WITH STEERING ASSIST

Adaptive Cruise Control with Steering Assist can be activated from 15km/h, and once activated will operate between 0-180km/h. It begins functioning when you depress the 'Set' cruise button. A camera and radar then work together to track lanes ahead to maintain a central position for your vehicle, and moderate its speed according to the behaviour of the traffic ahead of you. If the vehicle ahead slows, even to a standstill, the feature automatically slows your vehicle, bringing it to a stop where necessary, to maintain a relaxed and composed drive in busy traffic situations.

Adaptive Cruise Control with Steering Assist works with you; as you keep your hands on the wheel anticipating the road ahead, the system assists with steering, braking and acceleration. Should you remove your hands from the wheel, the vehicle will provide a warning. If the warning is not heeded then the Steering Assist is deactivated, but the Adaptive Cruise Control remains active.

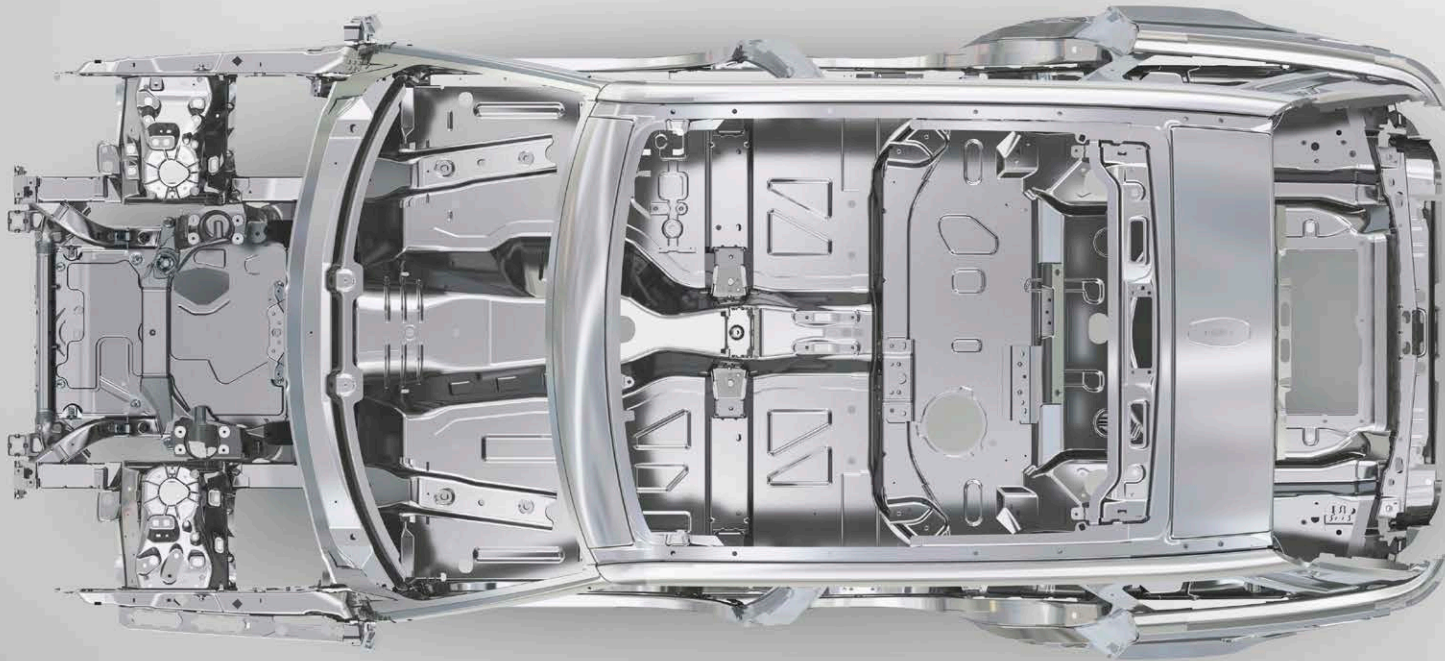

EFFICIENT TECHNOLOGIES

SUSTAINABLE BY DESIGN

Land Rover are committed to producing vehicles that use more sustainable materials, produce less waste and use fewer natural resources as part of our approach to sustainable business. Range Rover Sport's development process has included a full life-cycle assessment and has been designed to be 85 percent recyclable/reusable and 95 percent recoverable at the end of the vehicle's life.

Our innovative design enables the use of a unique alloy in the vehicle body, made from up to 50 percent recycled aluminium derived from our closed-loop manufacturing process, retaining quality and performance but delivering lower life cycle CO₂ emissions. Closed-loop manufacturing means taking the scrap from the body pressings process, segregating it and re-melting it back into quality sheet aluminium at our supplier, to be used again to press out body panels, thereby reducing the need to use primary aluminium.

ENGINE MANUFACTURING CENTRE

Jaguar Land Rover's Engine Manufacturing Centre, where our Ingenium engines are assembled, has been built to the highest environmental standard (BREEAM Excellent) and features one of the largest rooftop solar panel installations in the UK. Comprising no fewer than 22,600 individual panels, with 6.2MW generating capacity, the panels have the capability to provide up to 30 percent of the site's energy needs.

ECO MODE

Eco Mode ensures the vehicle runs more efficiently and economically by using software to implement a range of actions, from softening the pedal on throttle and gear changes, to retuning the heating, ventilation and air conditioning when in Auto Mode and switching off heated door mirrors.

LOW CO₂ TECHNOLOGIES

Range Rover Sport powertrains incorporate a variety of low CO₂ technologies. Our intelligent Stop/Start system* is designed to improve fuel efficiency and reduce emissions. Mild Hybrid Electric Vehicle (MHEV) - considered the next generation of Stop/Start technology - takes this even further. Our latest Plug-in Hybrid Electric Vehicle (PHEV) ensures both optimum performance and efficiency.



*Market dependent.

SAFETY

SAFE AND SECURE

With its strong, powerful stature, Range Rover Sport provides a high degree of protection. Its all-aluminium monocoque body makes it one of the strongest vehicles of its kind. The inclusion of high-strength aluminium in the body structure ensures minimum intrusion into the safety cell in the event of a collision, while the elevated Sports Command Driving Position provides enhanced visibility in all conditions. You can see more of the road and be easily seen by other road users, providing an enhanced feeling of safety and confidence.

It has also been engineered to include a wealth of standard features, not only to protect you and your passengers, but to actively help prevent accidents occurring:

Dynamic Stability Control (DSC) monitors Range Rover Sport's dynamic behaviour, intervening to maximise vehicle stability. DSC reduces engine torque and applies braking to the appropriate wheels, to correct the vehicle's direction of travel by counteracting understeer or oversteer.

Anti-lock Braking System (ABS) allows the vehicle to maintain traction with the road surface whilst braking and prevents wheels from locking - thereby retaining the vehicle's ability to steer. The system helps to shorten the braking distance.

Electronic Brake-force Distribution (EBD) automatically varies the braking force to each axle in order to minimise stopping distance, while still maintaining stability and the vehicle's ability to steer.



Electronic Traction Control (ETC) optimises traction and stability by controlling wheel spin. The ETC system reduces torque to the spinning wheel, then applies braking to the wheel, if required.

Cornering Brake Control (CBC) automatically varies the braking force to each wheel when the vehicle's brakes are applied around a corner and the limit of grip is reached. The system will prevent the vehicle's wheels from locking up and skidding in this event, through varying the braking force applied to each wheel.

Roll Stability Control (RSC) is integrated with DSC to reduce the possibility of rollover, while providing agility and ability to steer around obstacles. It monitors the vehicle motion and cornering forces to detect any potential risk of rollover. When risk is detected, braking is applied to the outside front wheel to reduce forces that contribute to rollover.

Emergency Brake Assist (EBA) understands when you apply the brakes quickly but without the necessary force to maximise stopping performance. It therefore boosts the brake pressure through the ABS pump to ensure you stop in time.

Hazard Lights Under Braking - To help reduce the risk of a collision, the Emergency Stop Signal system automatically activates the hazard warning lights during emergency braking.

To improve safety further for all the family, two ISOFIX points for baby/child seat restraints are fitted on each side of the rear seats, and additional protection is offered by seat belt pretensioners which, in the event of a front impact, reduce forward movement. To further protect you, there is a comprehensive system of airbags including driver and passenger airbags, side curtain and thorax.

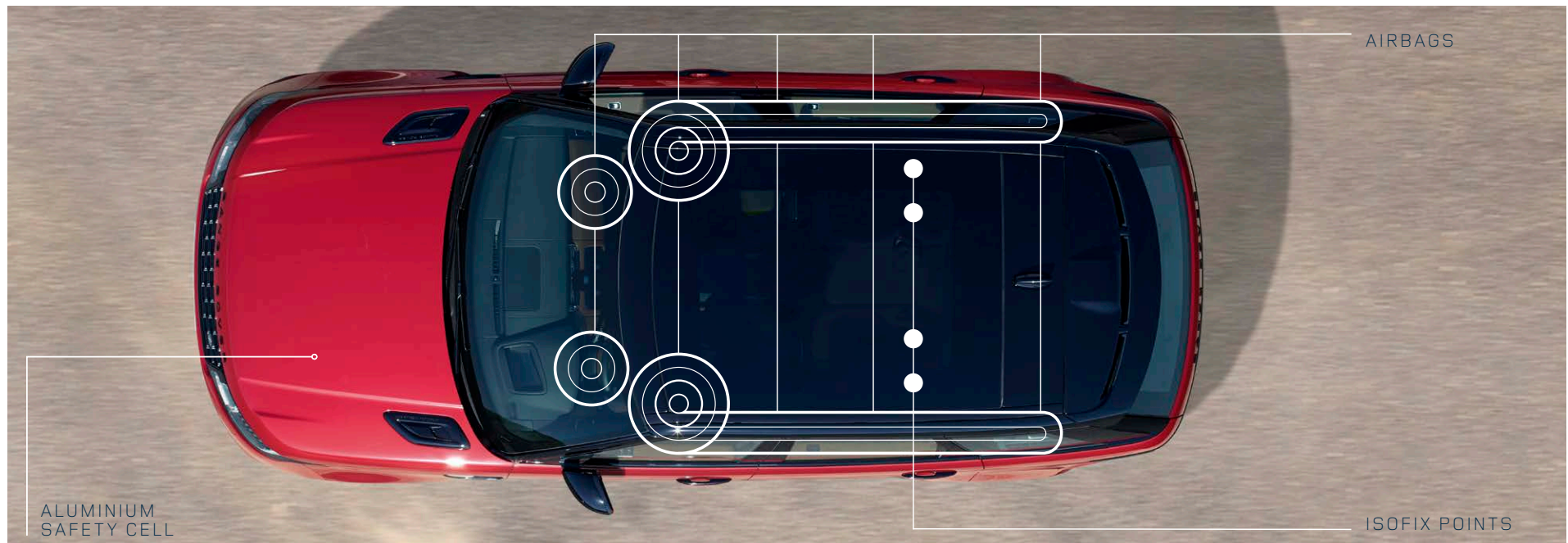



LIGHTING TECHNOLOGY

Range Rover Sport features all-round exterior LED lighting with standard features including signature Daytime Running Lights, automatic headlights and power wash. LED lights are designed to last the lifetime of the vehicle and are more energy efficient. Also, the quality of light produced is closer to daylight conditions, so driving at night becomes less tiring.

A range of beam pattern assistance features provide maximum light while minimising the impact on other road users. The standard Premium LED headlights can be enhanced by the optional Auto High Beam Assist, which turns on the main beam and dips it when other road users are detected.

Optional Matrix LED headlights and Pixel LED headlights both feature an Adaptive Front-lighting System (AFS) and also enable Advanced Driving Beam (ADB). The AFS optimises the lighting beam to suit a range of driving conditions: town, country, motorway and bad weather, while the ADB allows you to use both the high and low beam concurrently. By splitting the main beam into vertical strips, the Matrix LED headlights can cast four vertical shadows in front of a vehicle ahead, to prevent dazzling without having to dip the main beam and lose the illumination. The Matrix LED headlights also feature front and rear Animated Directional Indicators which illuminate with a distinctive sweeping pattern.

Optional Pixel LED headlights, with nearly three times as many LEDs than the Matrix headlights, offer our most advanced headlight technology and build on the ADB capability to ensure maximum light. By splitting the main beam pattern vertically and horizontally, they enable up to four higher definition shadows, to avoid dazzling multiple vehicles ahead. This headlight option incorporates bending lights which operate at higher speeds to direct the main beam pattern according to the direction of steering.

Optional Pixel-laser LED headlights build on the Pixel LED headlight option with the addition of laser technology. The long-range laser delivers five times higher luminance than standard LED lights and is particularly useful for long, straight road driving. They become operational above 80km/h and when no other external lights are detected, to produce clear sight for over half a kilometre.

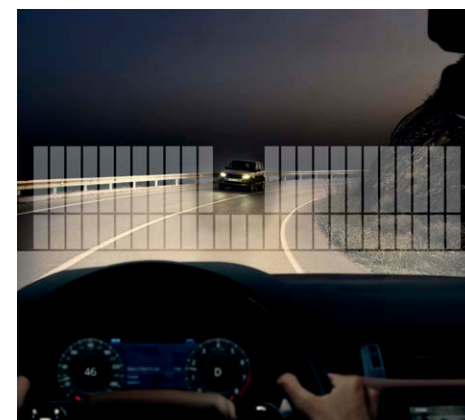

HEADLIGHT FEATURES	PREMIUM LED HEADLIGHTS	MATRIX LED HEADLIGHTS	PIXEL LED HEADLIGHTS	PIXEL-LASER LED HEADLIGHTS
Number of LEDs per vehicle	24	52	142	144
Auto High Beam Assist (AHBA)	□	■	■	■
Adaptive Front Lighting (AFS)	-	■	■	■
Front and rear Animated Directional Indicators	-	■	■	■
Matrix Advanced Driving Beam (ADB)	-	■	-	-
Pixel Advanced Driving Beam (ADB)	-	-	■	■
Dynamic bending light	-	-	■	■
Laser high beam	-	-	-	■
Signpost dimming	-	■	■	■
Tourist Mode	-	-	■	■

■ Standard □ Optional - Not Available.

Features and their availability may differ by vehicle specification and market. For full feature and option availability please refer to the online configurator or visit your local Land Rover Retailer.



VERSATILITY

AUTOMATIC ACCESS HEIGHT 50MM

TRULY FLEXIBLE

AUTOMATIC ACCESS HEIGHT

Range Rover Sport has the versatility to meet all your needs. While the exemplary levels of comfort are complemented by a range of innovative features which add to the convenience, luxury and ease of every journey.

Automatic Access Height, as part of the Electronic Air Suspension, allows you to get in and out of the vehicle with greater ease and elegance as, when activated, this feature lowers the vehicle by as much as 50mm when the vehicle comes to a halt and the door is opened. Optional Clear Exit Monitor provides an alert to rear seat passengers prior to them leaving the vehicle, to prevent the door opening onto approaching obstacles. The vehicle is also available with optional soft door close to provide power latching on the front and rear doors.

INTERIOR CLIMATE

To prevent the cabin from overheating in the sun and minimise demands on the air conditioning, the **auto sunblind**¹ closes automatically when passengers have disembarked and the doors locked. When the vehicle is re-opened, the sunblind returns to the position prior to it auto-closing.

¹Standard when panoramic roof is specified.

Features and their availability may differ by vehicle specification and market. For full feature and option availability please refer to the online configurator or visit your local Land Rover Retailer.

Vehicle shown is Autobiography with Dynamic Pack in Firenze Red with optional features fitted (market dependent).



5+2 SEATS²

DRY	WET
162	221
LITRES	LITRES



5 SEATS

DRY	WET
623	780
LITRES	LITRES



4 SEATS

DRY	WET
959	1,142
LITRES	LITRES



3 SEATS

DRY	WET
1,127	1,324
LITRES	LITRES



2 SEATS

DRY	WET
1,463	1,686
LITRES	LITRES

LOADSPACE

The optional Cabin Air Ionisation with Nanoe™ technology improves the air quality within the vehicle cabin, and reduces allergens, viruses, airborne bacteria and associated odours. It does so by ionising particles in the air, making them attract to surfaces and thus helping to cleanse the air. Optional Four-zone Climate Control helps make life more comfortable for everyone, utilising a fully independent rear heating and air conditioning unit to ensure all occupants enjoy optimum comfort.

Range Rover Sport has a generous 780 litres of available loadspace or up to 1,686 litres when the rear seats are stored flat. All models come with a 60:40 split second row seat as standard, with an optional load through feature (ideal for long items such as skis). The versatile seating accommodates up to seven occupants. The **5 + 2 arrangement** has two seats stowed under the floor of the luggage compartment, which are split 50:50, with no loss of loadspace. The second row seats have forwards/backwards movement of 100mm allowing for better access to the third row.

²Not available on S or SVR models. Not available with SDV8 or P400e engines.

Dry: Volume as measured with VDA-compliant solid blocks (200mm x 50mm x 100mm). Wet: Volume as measured by simulating the loadspace filled with liquid.

On P400e variants, the loadspace capacity is reduced by up to 79 litres and the loadspace floor is raised by 46mm. Please contact your local Land Rover Retailer for more information.

Nanoe™ is a trademark of Panasonic Corporation.

The third row seats are suitable for use by older children who can either use the adult belt or a booster seat in conjunction with the adult belt. They are not suitable for smaller children who require a child seat where the adult belt is not used directly to restrain the child.



BUSINESS

POWER AND STOWAGE

With a flexible and contemporary interior, Range Rover Sport is designed to enhance your business activities.

With **two optional mains voltage outlets**¹ and **five USB ports** located throughout the cabin, multiple electronic devices can be charged on the go. And to ensure your cabin is clutter-free, there is increased stowage space, from a recess specifically for smartphones to the upper glovebox and deep stowage compartments.

The optional **front centre console refrigerator compartment** provides the luxury of cooling drinks on demand. It can accommodate up to four 500ml bottles and maintain them at a temperature of 5°C, with the ability to achieve -5°C degrees for short periods to deliver rapid cooling. A border light indicates when it has been switched on.



LEISURE

ACTIVITY KEY

With the optional **Activity Key** you can enjoy your favourite activities and keep your vehicle key securely in the vehicle. For extra convenience, you can strap the Activity Key to your wrist. The wristband is robust and fully waterproof, allowing you to take part in a range of activities from cycling to swimming. Simply touch your Activity Key on the tailgate (behind the letter R in the Range Rover script) to lock or unlock the vehicle and deactivate or reactivate the conventional key fob.

TAILGATE

Access to the considerable rear space is now more convenient than ever. **Rear Height Adjust** lowers the rear suspension by up to 50mm when the tailgate is opened. This creates a more natural ramp angle, with the lowered rear improving both loadspace accessibility and ease of loading. **Powered gesture tailgate²** allows you to open and close the tailgate from the kerb without needing to touch either the vehicle or the key fob. And as the system is compatible with optional towing solutions, you can still tackle demanding situations with the least amount of fuss.

²Optional on S and SE. Requires Keyless Entry.

Features and their availability may differ by vehicle specification and market. For full feature and option availability please refer to the online configurator or visit your local Land Rover Retailer.





TOWING

With a towing capacity of up to 3,500kg¹ and by incorporating tailored technologies, Range Rover Sport can handle the most demanding of tasks.

ELECTRICALLY DEPLOYABLE TOW BAR²

This optional system is deployed using a convenient button in the loadspace compartment, or via the Touchscreen.

TOW HITCH ASSIST

Tow Hitch Assist makes coupling a trailer to the vehicle much easier by helping you visualise the hitching process; it displays the predicted path of the vehicle tow ball towards the trailer tow bar on the Touchscreen.

REAR HEIGHT ADJUST

Rear Height Adjust allows the use of switches in the loadspace or on the key fob to lower the rear suspension height by up to 50mm - useful when loading or unloading cumbersome items, or when hitching, unhitching or loading a trailer.

TOW ASSIST

Tow Assist helps with reversing by predicting the trailer's direction. The system displays the predicted path of both the vehicle and the trailer as coloured trajectory lines on the Touchscreen. For precise guidelines you can even choose your trailer's width. Standard with 360° Surround Camera.

ADVANCED TOW ASSIST

Advanced Tow Assist allows you to control the direction of your trailer when reversing by using the rotary Terrain Response 2 controller. The optional system will control the vehicle's steering to achieve the desired trailer trajectory.

TRAILER STABILITY ASSIST

Trailer Stability Assist (TSA) gives you greater stability when towing. Should TSA detect a dangerous trailer sway situation is developing, it can help you regain control by gradually reducing Range Rover Sport's speed, through lowering engine power and applying the brakes individually on each side of the vehicle to control the sway.

¹2,500kg limit on P400e models. 3,000kg limit on SVR and Si4 models. ²Electrically deployable tow bar is not available for P400e. Alternatively, fixed multi-height tow bar can be fitted as a Retailer-fit accessory.

Features and their availability may differ by vehicle specification and market. For full feature and option availability please refer to the online configurator or visit your local Land Rover Retailer.

Vehicle shown is Autobiography with Dynamic Pack in Firenze Red with optional features fitted (market dependent).





RANGE ROVER SPORT SVR



SPECIAL VEHICLE OPERATIONS

Designed and engineered by Special Vehicle Operations (SVO) - Land Rover's Centre of Excellence for bespoke commissions, luxury editions and performance models - Range Rover Sport SVR is our fastest and most capable performance SUV ever. With a bold, assertive design and an even more exhilarating performance, SVR stirs the emotions like no other Land Rover.

PERFORMANCE AND DESIGN

The 5.0 litre V8 Supercharged Petrol 575PS engine delivers a powerful 700Nm of torque, taking it from 0-100km/h in 4.5 seconds and to a top speed of 280km/h. SVR Dynamic Response is enhanced so that the vehicle corners flatter and faster than any other Land Rover, whilst SVR Sport Suspension is optimised for performance and delivers improved handling. The integrated quad tailpipes with Active Exhaust provide its distinctively throaty engine sound. And with mud and snow tyres available on 22" wheels, this vehicle now delivers breathtaking SVR performance in the most challenging conditions.

SVR's all-round enhanced capability is accentuated by the broad shouldered, muscular stance. A look that is complemented by a unique mesh grille and side fender vents in Narvik Black. Design is purposeful with features optimising both form and function. Engine cooling and airflow to the brakes is maximised by the enhanced front bumper.

The bonnet can also be specified in an optional striking exposed Carbon Fibre which dramatically enhances SVR's sporting character.

A range of options offer a high degree of personalisation, including 22" lightweight SVR alloy wheels and brake calipers in Red or Gloss Black. An even sportier look is achieved when you choose the exposed Carbon Fibre bonnet with the optional Carbon Fibre Pack. This is further enhanced by the optional SVR Carbon Fibre engine cover, which provides the benefit of being lightweight and adds a premium finish to the engine compartment.

Features and their availability may differ by vehicle specification and market. For full feature and option availability please refer to the online configurator or visit your local Land Rover Retailer.

Vehicle shown is SVR in Velocity Blue with optional features fitted (market dependent).





INTERIOR

Land Rover's fastest SUV takes driver and passenger comfort to the very highest levels.

Providing a supreme degree of comfort and control, the lightweight SVR Performance seats in Windsor leather are heated as standard and offer cooling as an option. These sleeker seats are available in four colourways and Cut Diamond perforation styling.

This vehicle is unmistakably SVR. The unique, sportier steering wheel has trim matched to the interior colourway with SVR branding. The SVR logo is also embossed on the headrest and highlighted on the fascia centre panel. More dynamic touches are delivered throughout with the use of premium finishers, including Satin Brushed Aluminium and Grand Black. Further refinements are available, including the Gloss Carbon Fibre trim finisher with a Gloss Carbon Fibre lower finisher on the steering wheel.

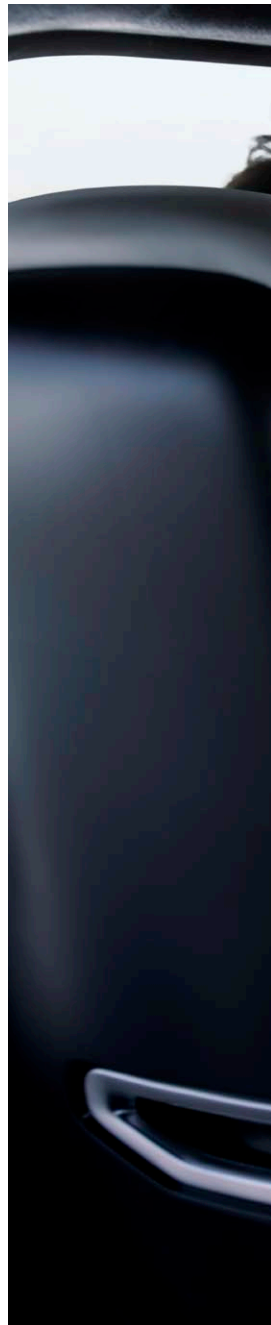



SPECIFICATIONS



CHOOSE YOUR MODEL

Each model has a choice of engines and unique features. This guide will help you to select your ideal Range Rover Sport. On the following pages you will see the standard features for each model: S, SE, HSE, HSE with Dynamic Pack, Autobiography with Dynamic Pack and SVR.

To find out more and see your model specification, configure your Range Rover Sport at landrover-me.com/RangeRoverSport





STANDARD FEATURES FOR ALL MODELS

DYNAMICS

- Electronic Air Suspension
- 8-speed Automatic Transmission
- All Wheel Drive (AWD)
- Electric Power Assisted Steering (EPAS)
- Dynamic Stability Control (DSC)
- Eco Mode
- Low Traction Launch
- Electronic Traction Control (ETC)
- Roll Stability Control (RSC)
- Cornering Brake Control (CBC)
- Hill Descent Control (HDC)
- Electric Parking Brake (EPB)
- Electronic Brake-force Distribution (EBD)
- Gradient Acceleration Control (GAC)
- Gradient Release Control (GRC).

EXTERIOR FEATURES

- Roof rack mounting provisions
- Heated rear window
- Acoustic laminated windscreen
- Rain sensing windscreen wipers.

EXTERIOR LIGHTING

- Automatic headlights
- Daytime Running Lights (DRL)
- LED tail lights
- Follow me home lighting
- Centre high-mounted stop light
- Rear fog lights
- Headlight power wash.

WHEELS AND TYRES

- Tyre Pressure Monitoring System (TPMS).

TOWING

- Trailer Stability Assist (TSA)
- Electrical towing preparation
- Front and rear recovery eyes.

INTERIOR FEATURES

- Multi-function steering wheel
- Sunvisors with illuminated vanity mirrors
- Electric windows with one-touch open/close and anti-trap
- Lockable upper and lower fascia glovebox
- Front and rear cup holders
- Front and rear grab handles
- Driver footrest
- Front door storage space.

CONVENIENCE

- Push Button Start
- Centre console with armrest
- Rear centre armrest
- Loadspace light
- Loadspace mounting provisions
- 60:40 split second row seats.

INFOTAINMENT

- Touch Pro Duo
- 12.3" Interactive Driver Display
- Navigation Pro
- Voice control
- Power sockets
- All Terrain Info Centre
- Bluetooth® connectivity.

DRIVER ASSISTANCE

- Lane Departure Warning
- Cruise Control and Speed Limiter
- Front and Rear Parking Aid.

SAFETY

- Anti-lock Braking System (ABS)
- Emergency Brake Assist
- Hazard lights under braking
- Perimetric alarm
- Customer configurable autolock
- Height adjustable seat belts
- Customer configurable single point entry
- Power operated child locks
- Rear ISOFIX on outer seats
- Front airbags, with passenger seat occupant detector
- Seat belt pretensioners.

SELECT YOUR RANGE ROVER SPORT MODEL

SE





SE (IN ADDITION TO STANDARD FEATURES)	
WHEELS	<ul style="list-style-type: none"> - 19" Style 5001, 5 split-spoke alloy wheels¹ - Tyre Repair System.
EXTERIOR FEATURES	<ul style="list-style-type: none"> - Shadow Atlas grille mesh with Bright trim - Bright Silver bonnet vent and side vent details on Gloss Black surrounds - Bright Silver bonnet and tailgate script - Gloss Black tailgate appliqué - Unpainted sills, bumper corners and tow eye cover surrounds - Body-coloured mirror caps - Heated door mirrors.
EXTERIOR LIGHTING	<ul style="list-style-type: none"> - Premium LED headlights with signature DRL - Front fog lights.
INTERIOR FEATURES	<ul style="list-style-type: none"> - Grained leather seats - 14-way powered front seats - Dark Satin Brushed Aluminium trim finisher - Morzine headlining - Leather steering wheel - Ambient Interior Lighting - Auto-dimming interior rear view mirror.
CONVENIENCE	<ul style="list-style-type: none"> - Two-zone Climate Control.
INFOTAINMENT	<ul style="list-style-type: none"> - Enhanced Sound System with eight speakers (250W)².
DRIVER ASSISTANCE	<ul style="list-style-type: none"> - Rear Camera.

¹20" 5 split-spoke 'Style 5084' alloy wheels with P400 and P400e.
²Meridian™ Surround Sound system with P400e.

HSE



HSE WITH DYNAMIC PACK





	HSE (IN ADDITION TO STANDARD FEATURES)	HSE WITH DYNAMIC PACK (IN ADDITION TO STANDARD FEATURES)
WHEELS	<ul style="list-style-type: none"> - 20" Style 5084, 5 split-spoke alloy wheels - Full size spare wheel³. 	<ul style="list-style-type: none"> - 21" Style 5085, 5 split-spoke alloy wheels with Silver finish - Full size spare wheel³ - Red brake calipers (on P400, P400e, SDV8 and V8 Supercharged Petrol engines)¹.
EXTERIOR FEATURES	<ul style="list-style-type: none"> - Shadow Atlas grille mesh with Bright trim - Bright Silver bonnet vent and side vent details on Gloss Black surrounds - Bright Silver bonnet and tailgate script - Gloss Black painted sills and bumper corners - Gloss painted tow eye cover surrounds - Bright Silver tailgate appliqué - Power fold, heated door mirrors with memory and approach lights - Fixed panoramic roof - Integrated exhaust². 	<ul style="list-style-type: none"> - Body-coloured sills and bumper corners - Shadow Atlas grille mesh and trim - Gloss Black tailgate appliqué - Shadow Atlas bonnet and tailgate script - Shadow Atlas bonnet vent and side vent details on Gloss Black surrounds - Body-coloured and Gloss Black tow eye cover and surrounds - Power fold, heated door mirrors with memory and approach lights - Fixed panoramic roof - Integrated exhaust. <p>Also available with Black Pack. See pages 68-69.</p>
EXTERIOR LIGHTING	<ul style="list-style-type: none"> - Matrix LED headlights with signature DRL - Front fog lights. 	<ul style="list-style-type: none"> - Matrix LED headlights with signature DRL - Front fog lights.
INTERIOR FEATURES	<ul style="list-style-type: none"> - Windsor leather seats - 16-way heated front seats with memory - Micro Mesh Aluminium trim finisher - Morzine headlining - Leather steering wheel - Black gearshift paddles - Front centre console cooler compartment - Electrically adjustable steering column - Ambient Interior Lighting - Auto-dimming interior rear view mirror - Aluminium treadplates with Range Rover script. 	<ul style="list-style-type: none"> - Windsor leather seats - 16-way heated front seats with memory - Dark Engine Turned Aluminium trim finisher - Morzine headlining - Leather steering wheel with Bright Silver finish bezel - Electrically adjustable steering column - Front centre console cooler compartment - Ambient Interior Lighting - Auto-dimming interior rear view mirror - Illuminated metal treadplates with Range Rover script - Satin Chrome gearshift paddles - Bright metal pedals.
CONVENIENCE	<ul style="list-style-type: none"> - Powered gesture tailgate - Four-zone Climate Control - Keyless Entry - Soft door close. 	<ul style="list-style-type: none"> - Powered gesture tailgate - Four-zone Climate Control - Keyless Entry - Soft door close.
INFOTAINMENT	<ul style="list-style-type: none"> - Enhanced Sound System with eight speakers (250W)⁴. 	<ul style="list-style-type: none"> - Enhanced Sound System with eight speakers (250W)⁴.
DRIVER ASSISTANCE	<ul style="list-style-type: none"> - Rear Camera. 	<ul style="list-style-type: none"> - Rear Camera.

¹Grey anodised brake calipers with Land Rover script are standard with V6 Supercharged 340PS engines. ²Not available with Si4 and SDV6 249PS SE and HSE models.

³Not available with P400e. ⁴Meridian™ Surround Sound System with P400e.

Features additional to the previous model are highlighted in bold.

AUTOBIOGRAPHY WITH DYNAMIC PACK





AUTOBIOGRAPHY WITH DYNAMIC PACK
(IN ADDITION TO STANDARD FEATURES)

WHEELS

- **21" Style 5085, 5 split-spoke with Diamond Turned finish alloy wheels**
- Full size spare wheel*
- Red brake calipers (on P400, P400e, SDV8 and V8 Supercharged Petrol engines).

EXTERIOR FEATURES

- **Gloss Black bonnet and side vents**
- Gloss Black tailgate appliqué
- **Gloss Black bonnet and tailgate script**
- **Gloss Black Sport badge**
- **Gloss Black trimmed premium door handles**
- **Black contrast fixed panoramic roof**
- **Auto-dimming (driver's side only), power fold, heated door mirrors with memory and approach lights**
- Integrated exhaust.

Also available with Bright Pack and Exterior Carbon Fibre Pack. See page 69.

EXTERIOR LIGHTING

- Matrix LED headlights with signature DRL
- Front fog lights.

INTERIOR FEATURES

- **Semi-Aniline leather seats**
- **22 way heated and cooled memory front seats with winged headrests**
- **Grand Black veneer**
- **Suedecloth headlining**
- Leather steering wheel with Bright Silver finish bezel
- Electrically adjustable steering column
- **Configurable Ambient Interior Lighting**
- Front centre console cooler compartment
- Auto-dimming interior rear view mirror
- **Premium carpet mats**
- Illuminated metal treadplates with Range Rover script
- Satin Chrome gearshift paddles
- Bright metal pedals.

CONVENIENCE

- **60:40 load through rear seats (ideal for long items such as skis)**
- Powered gesture tailgate
- Four-zone Climate Control
- Keyless Entry
- Soft door close.

INFOTAINMENT

- **Meridian™ Surround Sound System with 18 speakers and a subwoofer (825W).**

DRIVER ASSISTANCE

- Rear Camera
- **Blind Spot Monitor**
- **Driver Condition Monitor**
- **360° Parking Aid**
- **Clear Exit Monitor**
- **Rear Traffic Monitor.**

*Not available with P400e.

Features additional to the previous model are highlighted in bold.

SVR





SVR (IN ADDITION TO AUTOBIOGRAPHY WITH DYNAMIC PACK)	
WHEELS	<ul style="list-style-type: none"> - 21" Style 5091, 5 split-spoke with Satin Polish finish alloy wheels - Reduced section alloy spare wheel - Red brake calipers.
EXTERIOR FEATURES	<ul style="list-style-type: none"> - Unique SVR front and rear bumpers - Unique SVR spoiler - Black contrast roof - Auto-dimming (driver's side only), power fold, heated door mirrors with memory and approach lights.
EXTERIOR LIGHTING	<ul style="list-style-type: none"> - Pixel LED headlights with signature DRL.
INTERIOR FEATURES	<ul style="list-style-type: none"> - SVR heated front and rear Performance seats - Extended Satin Brushed Aluminium trim finisher - Suedecloth headlining - SVR branded leather steering wheel - Electrically adjustable steering column - Configurable Ambient Interior Lighting - Auto-dimming interior rear view mirror - Premium carpet mats - Illuminated metal treadplates with Range Rover script - Aluminium gearshift paddles - Bright metal pedals.
CONVENIENCE	<ul style="list-style-type: none"> - Powered gesture tailgate - Four-zone Climate Control - Keyless Entry - Soft door close.
INFOTAINMENT	<ul style="list-style-type: none"> - Meridian™ Surround Sound System with 18 speakers and a subwoofer (825W).
DRIVER ASSISTANCE	<ul style="list-style-type: none"> - Rear Camera - Blind Spot Monitor - Driver Condition Monitor - 360° Parking Aid - Clear Exit Monitor - Rear Traffic Monitor.



CHOOSE YOUR ENGINE

WHICH ENGINE IS RIGHT FOR YOU?

Lots of people struggle with this. But the truth is that it really depends on what your priorities are and the type of driving you do. Diesel engines are more powerful than petrol engines. They have a higher torque and so give a smoother drive. And they're more fuel-efficient than petrol, particularly out of town on long journeys. On the other hand, the harshness, noise, and vibrations in diesel driven cars are higher than that of a petrol-driven car. Also, the maintenance cost of diesel cars is greater. Petrol cars are generally quieter and cheaper to run on shorter journeys. Plug-in Hybrid Electric Vehicles (PHEV) meanwhile provide all-electric performance at lower speeds, and traditional combustion performance on longer journeys.

DIESEL ENGINES

TDV6

The 3.0 litre V6 Turbocharged Diesel provides 258PS and an impressive 600Nm of torque, for smooth, progressive performance.

- The switchable coolant pump improves engine warm-up by modulating coolant flow to engine demand, for improved fuel economy and emissions.
- The two-stage oil pump reduces parasitic losses by matching the flow of lubricant to engine load, increasing engine efficiency.
- Improved response due to optimised turbocharger compressor, turbine and variable nozzle designs. Turbo bearings feature ceramic ball races to further reduce friction, and therefore improve on turbo lag.
- An eight-nozzle fuel injector design ensures perfect atomisation of the fuel injected, optimising combustion for power and emissions while keeping fuel consumption and CO₂ emissions to a minimum.

SDV6

The 3.0 litre V6 Twin Turbocharged Diesel engine produces 306PS and 700Nm of torque and is ideal for higher power and torque demand usage with exceptional driveability.

- The innovative parallel sequential twin turbochargers - a concept pioneered by Jaguar Land Rover - feature a ceramic ball bearing on the primary turbo to reduce friction for maximum throttle response.
- A switchable coolant pump and two-stage oil pump are used for optimal thermal energy management, improving operating efficiency.
- The piezo common rail fuel injection system enables precise control of the amount of fuel injected, creating a uniform mixture for more efficient combustion and less emissions.
- The engine utilises these technologies to offer premium refinement and performance.

SDV8

The 4.4 litre V8 Twin Turbocharged Diesel offers top-of-the-range performance with 339PS and a staggering 740Nm of torque between 1,750-2,250rpm.

- Helical and tangential inlet ports for low-speed swirl and high gas flow, with combustion chambers optimised for emissions performance.
- 2000 bar common rail fuel injection with Gen 3 Piezo injectors.
- Compounded Graphite Iron block with optimised thin wall section and aluminium alloy heads.
- Twin overhead camshafts and four valves per cylinder.



PETROL ENGINES

Si4

The high-performance Ingenium 300PS, 400Nm 2.0 litre 4-cylinder Turbocharged Petrol engine features upgrades to the boosting system.

- Delivering a peak torque of 400Nm between 1,500-4,000rpm.
- The updated turbocharger features a high-flow compressor wheel delivering 26 percent more air, enabling a peak power output of 300PS.
- The twin-scroll turbocharger features ceramic ball bearings, which reduces friction and improves transient response.

P360 OR P400

The 3.0 litre Ingenium inline 6-cylinder Petrol engine is available in two power outputs. It produces 360PS and 495Nm of torque, or 400PS and 550Nm of torque.

The combination of MHEV technology and a range of efficiency measures deliver an engine of superb performance and driveability, whilst producing impressively low CO₂ emissions.

- Mild Hybrid Electric Vehicle (MHEV) technology utilises a belt-driven integrated starter generator, a 48V lithium-ion battery and an electric supercharger for driveability, economy and refined Stop/Start operation.
- The twin-scroll Turbocharger in addition to the electric Supercharger delivers additional engine boost at higher engine speeds and seamless power delivery.
- Variable cam timing on both the intake and exhaust camshafts allows the nominal cam profile to be advanced or slowed for optimum combustion. Combined with Continuous Variable Valve Lift, this delivers class-leading levels of flexibility and control over engine breathing to maximise efficiency at every operating condition, enhancing performance whilst optimising fuel efficiency.

V8 SUPERCHARGED 525PS

With 525PS and 625Nm of torque, the 5.0 litre V8 Supercharged Petrol engine provides stunning performance for ultimate dynamism and driver engagement.

- The V8 has a compact and lightweight all-aluminium design, with impressively low levels of internal friction.
- The engine has been optimised around a state-of-the-art Bosch engine management system. This features high-pressure direct injection with a centrally mounted, multi-hole, spray-guided injection system.
- Fitted with a sixth generation, Twin Vortex System (TVS) supercharger, the engine offers superior thermodynamic efficiency and extremely refined noise levels. The supercharger fully utilises the additional capacity of the 5.0 litre engine, generating a torque profile that delivers outstanding levels of power in a linear and engaging manner.
- The result is an impressively powerful yet refined drivetrain that delivers on both sporting excitement and luxurious refinement whenever required.

V8 SUPERCHARGED 575PS

Exclusive to SVR the 5.0 litre Supercharged V8 Petrol engine has been updated to deliver 575PS and 700Nm of torque. This is enabled by a recalibration of the engine and its management system to increase maximum available boost pressure. Maximum torque is delivered at 3,500-5,000rpm.

Refer to V8 Supercharged Petrol engine for full details.



CHOOSE YOUR EXTERIOR

SELECT YOUR ROOF

Choose from a metal roof, or a fixed panoramic or sliding panoramic roof - both of which enhance the sense of space in the vehicle's interior and flood it with natural light. The fixed panoramic roof provides uninterrupted views of the surrounding environment. The sliding panoramic roof opens fully to let the outside in. You can select either a body-coloured or contrast roof in Narvik Black to further enhance your vehicle's exterior. Metal and panoramic roofs available with all colour finishes.



Body-coloured roof



Fixed panoramic roof



Sliding panoramic roof



Black contrast roof



SELECT YOUR PAINT COLOUR

Now you have chosen your preferred roof style, you can select your exterior paint colour. From rich, deep lustres to incandescent metallic patinas, our paints incorporate the latest in pigment technologies. Our solid paints produce a deep flat colour. Our metallics deliver a sparkle finish that is sure to catch the eye. And our optional premium metallic paints enhance both the colour and the intensity of the finish to give your vehicle even more presence.

SOLID



Narvik Black^{1 3}

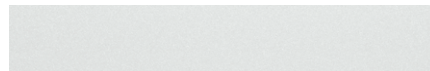

Fuji White

METALLIC



Santorini Black³



Firenze Red



Eiger Grey



Yulong White



Byron Blue¹



Estoril Blue²



Portofino Blue¹



Indus Silver

PREMIUM METALLIC



Carpathian Grey¹



Silicon Silver¹

¹Not available on SVR model. ²SVR model only. ³Not available with Black contrast roof.



SPECIAL VEHICLE OPERATIONS

SVO PREMIUM PAINT PALETTE

An optional range of specifically formulated ultra metallic and special effect premium palette colours and finishes are available. Whilst Bespoke by SVO offers a combination of colours and finishes, and will colour match to your exact requirement using our Match-to-Sample service. All ultra metallic and special effect colours come in a Gloss finish or, as an additional option, Satin Matte finish.

To find out more visit landrover-me.com/RangeRoverSport to configure your vehicle online.

ULTRA METALLIC



Ligurian Black*



Bosphorus Grey



British Racing Green



Madagascar Orange



Rio Gold



Mescalito Black*



Scafell Grey



Balmoral Blue



Velocity Blue



Verbier Silver



Borealis Black*



Windward Grey



Desire Deep Red



Flux Silver



Ethereal Frost Silver

SPECIAL EFFECT



Spectral British Racing Green



Spectral Racing Red



Spectral Blue



Meribel White Pearl

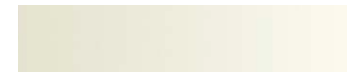

Valloire White Pearl



SELECT YOUR RANGE ROVER SPORT DESIGN PACK

You can tailor the exterior of your Range Rover Sport with the addition of any of the following packs: Black Design Pack, Bright Pack or Exterior Carbon Fibre Pack. Each one elevates the vehicle's sense of sophistication, with specific detailing providing another level of individuality.

BLACK EXTERIOR PACK



Optional pack on SE*, HSE*, and HSE with Dynamic Pack only

- Narvik Black bonnet and tailgate script
- Gloss Black main grille
- Narvik Black main grille surround
- Narvik Black bonnet vent inserts
- Narvik Black fender vent fingers
- Narvik Black mirror caps
- Black Sport badge.

*Not available with Si4 300PS engine on SE or HSE.



BRIGHT PACK



Optional pack on Autobiography with Dynamic Pack only

- Atlas Silver bonnet vents inserts
- Atlas Silver bonnet and tailgate script
- Shadow Atlas grille with Bright surround
- Atlas Silver door handle surrounds
- Atlas Silver fender vent fingers
- Gloss Black mirror caps (body-coloured if body-coloured roof is selected)
- Noble Silver tailgate appliqué
- Indus Silver rear bumper exhaust surround
- Atlas Silver Sport badge.

EXTERIOR CARBON FIBRE PACK



Retailer fit option

- Gloss Carbon Fibre bonnet vent inserts
- Gloss Carbon Fibre grille surround
- Gloss Carbon Fibre fender vent surround
- Gloss Carbon Fibre mirror caps
- Gloss Carbon Fibre tailgate finisher.

SELECT YOUR SVR PACK

The SVR Carbon Fibre Pack provides a superb enhancement to the Range Rover Sport SVR's undoubted sporty look. It is available in all exterior paint options and includes a Gloss finish Carbon Fibre grille surround, lower bumper intake surrounds, fender vent surrounds, mirror covers and tailgate finisher, with the additional option of an exposed Gloss finish Carbon Fibre bonnet (centre section only).

SVR (STANDARD)



- Body-coloured lower bumper intake surrounds
- Narvik Black main grille surround
- Narvik Black fender vent surround
- Narvik Black mirror covers
- Narvik Black tailgate finisher.



SVR CARBON FIBRE PACK*



- Gloss finish Carbon Fibre lower bumper intake surrounds
- Gloss finish Carbon Fibre main grille surround
- Gloss finish Carbon Fibre fender vent surround
- Gloss finish Carbon Fibre mirror covers
- Gloss finish Carbon Fibre tailgate finisher.

SVR CARBON FIBRE PACK WITH EXPOSED BONNET*



- Exposed Gloss finish Carbon Fibre bonnet (centre section only)
- Gloss finish Carbon Fibre lower bumper intake surrounds
- Gloss finish Carbon Fibre main grille surround
- Gloss finish Carbon Fibre fender vent surround
- Gloss finish Carbon Fibre mirror covers
- Gloss finish Carbon Fibre tailgate finisher.

*Requires optional Carbon Fibre bonnet as shown.

Features and their availability may differ by vehicle specification and market. For full feature and option availability please refer to the online configurator or visit your local Land Rover Retailer.



CHOOSE YOUR WHEELS

Sizes range from 19" to the highly desirable 22". With distinctive design cues, each one adds its own character to the overall look of the vehicle.

To see the wheels available on your model visit the configurator at landrover-me.com/RangeRoverSport



19" STYLE 5001
5 SPLIT-SPOKE
GLOSS SILVER (1)



20" STYLE 5084
5 SPLIT-SPOKE



21" STYLE 5085
5 SPLIT-SPOKE



21" STYLE 5085
5 SPLIT-SPOKE
SATIN DARK GREY WITH CONTRAST
DIAMOND TURNED FINISH



21" STYLE 5091
5 SPLIT-SPOKE
WITH SATIN POLISH FINISH (3)



21" STYLE 5007
5 SPLIT-SPOKE



21" STYLE 5007
5 SPLIT-SPOKE
WITH GLOSS BLACK
DIAMOND TURNED FINISH



21" STYLE 9001
9 SPOKE
WITH GLOSS BLACK FINISH (2)

(1) Not available with third row seats. Not available with P400e. (2) Only available with Black Pack or Carbon Fibre Exterior Pack on all models except Autobiography with Dynamic Pack. (3) SVR only. Wheel price and availability may differ by vehicle specification and market. For full feature and option availability please refer to the online configurator or visit your local Land Rover Retailer.



22" STYLE 5083
5 SPLIT-SPOKE
WITH GLOSS BLACK FINISH (3)



22" STYLE 5083
5 SPLIT-SPOKE
WITH SATIN POLISH FINISH (3)



22" STYLE 5086
5 SPLIT-SPOKE (1)



22" STYLE 5004
5 SPLIT-SPOKE
WITH GLOSS BLACK FINISH (1) (2)



22" STYLE 5004
5 SPLIT-SPOKE
GLOSS SILVER (1)



22" STYLE 9012
9 SPLIT-SPOKE
GLOSS BLACK (1) (2)



22" STYLE 9012
9 SPLIT-SPOKE
GLOSS DARK GREY WITH
CONTRAST DIAMOND TURNED FINISH (1)

CHOOSE YOUR INTERIOR

5 SEATS

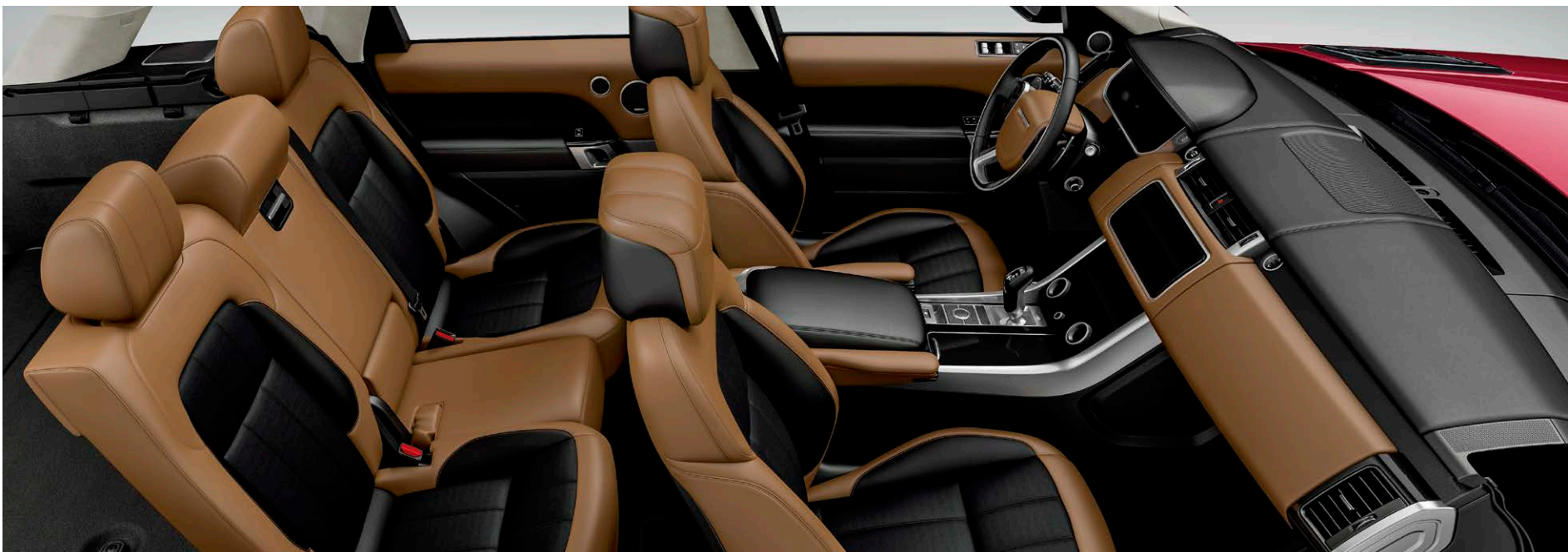

SELECT YOUR SEAT CONFIGURATION

5 seats

The seat configuration has been intelligently engineered to accommodate the lines of the roofline. The cabin is light and spacious, ensuring everyone has a relaxed and comfortable journey. There is generous leg, shoulder and head room throughout the contemporary cabin.

5 + 2 Seating

The 5 + 2 arrangement has two seats stowed under the floor of the luggage compartment that can be used for occasional use, enabling the vehicle to accommodate up to seven occupants.



5 + 2 SEATS

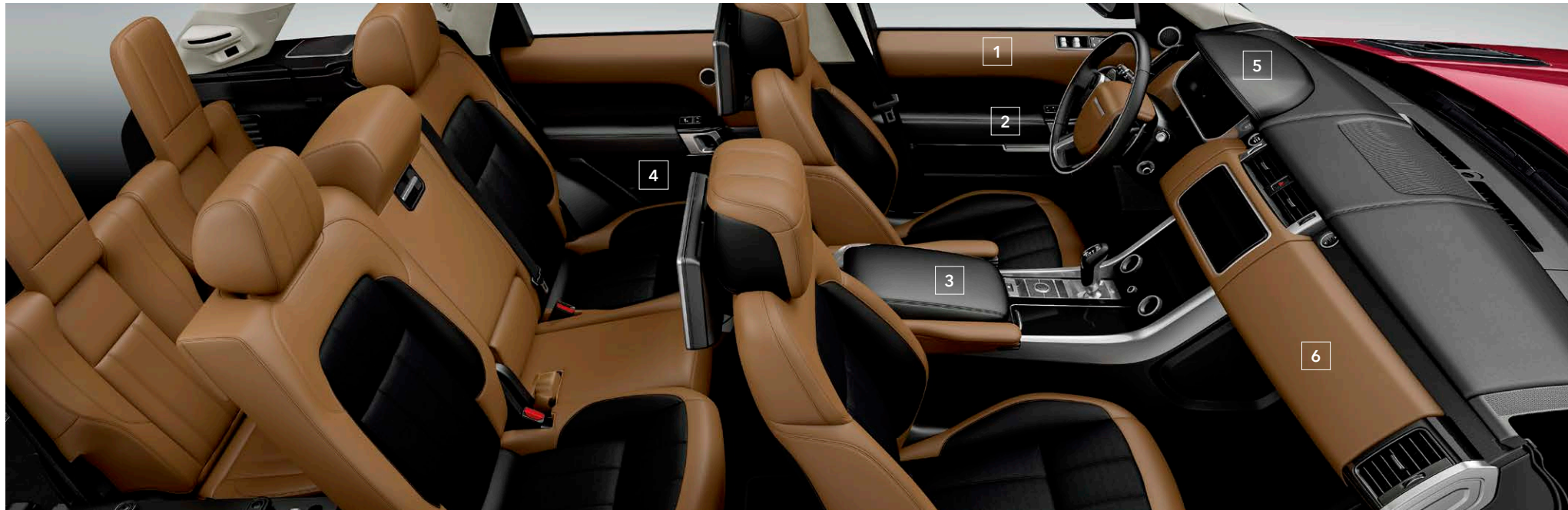

	1	2	3	4	5	6
COLOURWAYS See page 78	DOOR TOP ROLL	DOOR ARMREST	CUBBY LID	DOOR LOWER	INSTRUMENT PANEL UPPER	INSTRUMENT PANEL MID
(A) Ebony/Ebony	Ebony	Ebony	Ebony	Ebony	Ebony	Ebony
(B) Espresso/Almond**	Almond	Espresso	Espresso or Almond†	Espresso	Espresso	Almond
(C) Ebony/Ivory**	Ivory	Ebony	Ebony or Ivory†	Ebony	Ebony	Ivory
(D) Ebony/Vintage Tan*	Vintage Tan	Ebony	Ebony	Ebony	Ebony	Vintage Tan
(E) Ebony/Eclipse**	Eclipse	Ebony	Ebony	Ebony	Ebony	Eclipse
(F) Ebony/Pimento*	Pimento	Ebony	Ebony	Ebony	Ebony	Pimento
(G) Ebony/Cirrus (SVR only)*	Cirrus	Ebony	Ebony	Ebony	Ebony	Cirrus

*On SVR, steering wheel cover is Ebony with contrast stitching to match interior colourway selected. **Not available with SVR. †Cubby lid colour will match the seat colour. Steering wheel airbag cover for Autobiography with Dynamic Pack will reflect colourways as per instrument panel mid (6).

SELECT YOUR SEAT

Range Rover Sport's seats come in a variety of leathers, colourways and seat patterns, three of which are shown. Sportier than conventional seat designs, they further enhance the driver-focused cabin whilst ensuring optimum levels of comfort.

Note: Not all configurations can be shown here, so please configure your choices at landrover-me.com/RangeRoverSport

COLOURWAYS			EBONY/ EBONY	ESPRESSO/ ALMOND		EBONY/ IVORY		EBONY/ VINTAGE TAN	EBONY/ ECLIPSE	EBONY/ PIMENTO	EBONY/ CIRRUS
INTERIOR											
Seat colour			Ebony	Almond	Espresso	Ivory	Ebony/ Ivory	Ebony/ Vintage Tan	Ebony/ Eclipse	Ebony/ Pimento	Ebony/ Cirrus
Seat pattern			Mono-tone	Mono-tone	Mono-tone	Mono-tone	Duo-tone	Duo-tone	Duo-tone	Duo-tone	Duo-tone
Carpet			Ebony	Espresso	Espresso	Ebony	Ebony	Ebony	Ebony	Ebony	Ebony
MODEL	SEAT MATERIAL	SEAT MOVEMENTS									
SE	Grained leather	14	<input type="checkbox"/>	<input type="checkbox"/>	-	-	-	-	-	-	-
	Windsor leather	16	<input type="checkbox"/>	<input type="checkbox"/>	-	-	-	-	-	-	-
HSE	Windsor leather	16	<input type="checkbox"/>	<input type="checkbox"/>	<input type="checkbox"/>	<input type="checkbox"/>	-	-	-	-	-
	Semi-Aniline leather	22*	<input type="checkbox"/>	<input type="checkbox"/>	<input type="checkbox"/>	<input type="checkbox"/>	-	-	-	-	-
HSE with Dynamic Pack	Windsor leather	16	<input type="checkbox"/>	<input type="checkbox"/>	<input type="checkbox"/>	<input type="checkbox"/>	-	-	-	-	-
	Windsor leather with suedecloth bolsters	16	-	-	-	-	<input type="checkbox"/>	<input type="checkbox"/>	<input type="checkbox"/>	<input type="checkbox"/>	-
	Semi-Aniline leather	22*	<input type="checkbox"/>	<input type="checkbox"/>	<input type="checkbox"/>	<input type="checkbox"/>	<input type="checkbox"/>	<input type="checkbox"/>	<input type="checkbox"/>	<input type="checkbox"/>	-
Autobiography with Dynamic Pack	Semi-Aniline leather	22*	<input type="checkbox"/>	<input type="checkbox"/>	<input type="checkbox"/>	<input type="checkbox"/>	<input type="checkbox"/>	<input type="checkbox"/>	<input type="checkbox"/>	<input type="checkbox"/>	-
SVR	Windsor leather with suedecloth inserts	16	<input type="checkbox"/>	-	-	-	-	<input type="checkbox"/>	-	<input type="checkbox"/>	<input type="checkbox"/>

Optional - Not Available.

*20 with 8" Rear Seat Entertainment.



Mono-tone seat (Windsor leather) - Ebony. Available on SE, HSE, and HSE with Dynamic Pack.

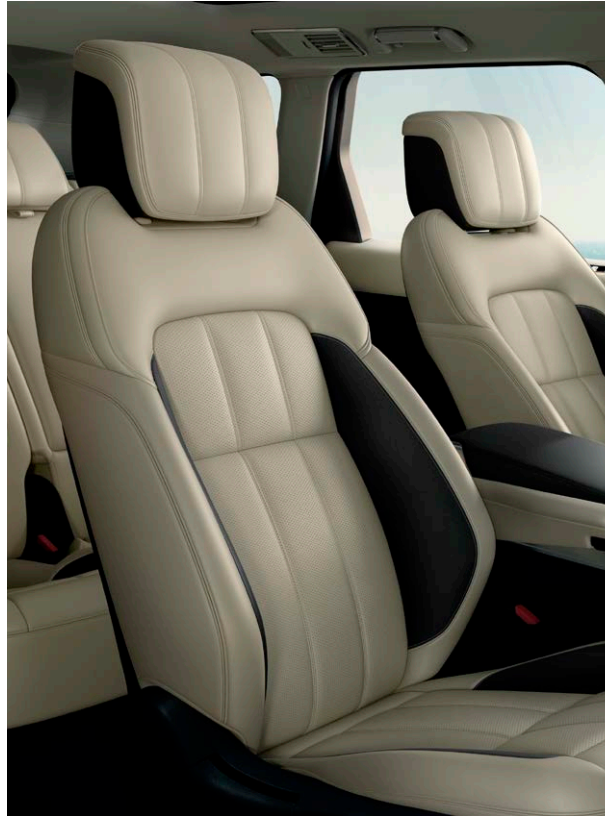

Duo-tone seat (Windsor leather with suedecloth bolsters) - Ebony/Ivory. Available on HSE with Dynamic Pack only.

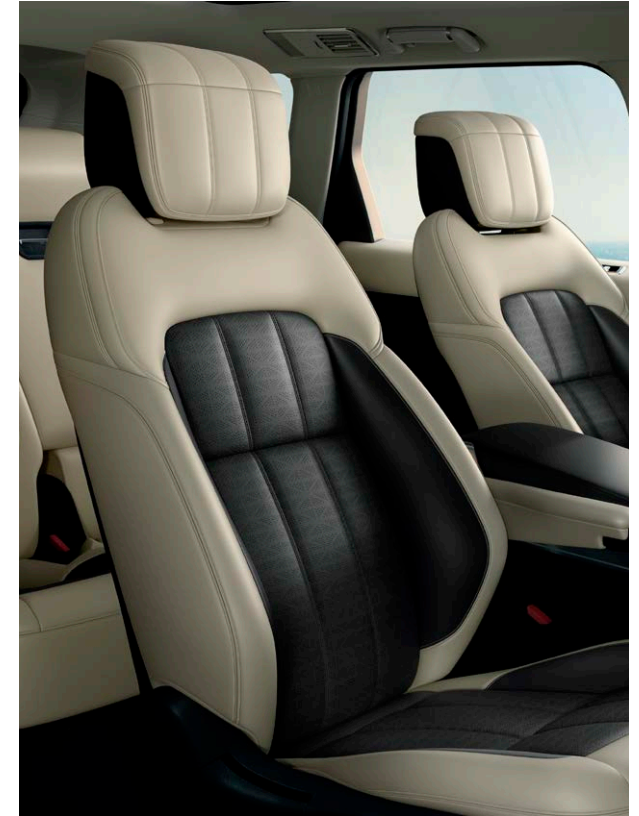

Duo-tone seat (Semi-Aniline leather) - Ebony/Ivory. Available on HSE with Dynamic Pack, HST and Autobiography with Dynamic Pack.

SELECT YOUR INTERIOR COLOUR COMBINATION

Now you have chosen your model, you can select the perfect combination of interior colours.



A. Ebony/Ebony



B. Espresso/Almond¹

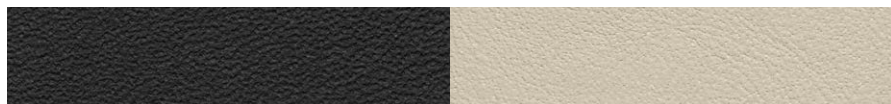

C. Ebony/Ivory¹



D. Ebony/Vintage Tan

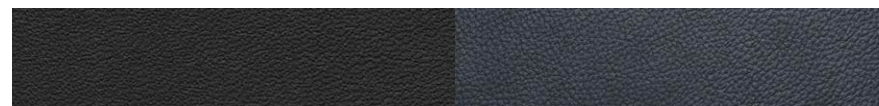

E. Ebony/Eclipse¹

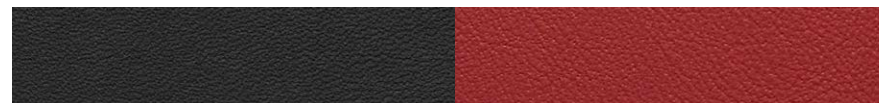

F. Ebony/Pimento

SVR ONLY



G. Ebony/Cirrus²



SELECT YOUR INTERIOR FINISHER

Now you've chosen your interior colourway, choose from a selection of interior finishers that are beautifully displayed in the cabin.

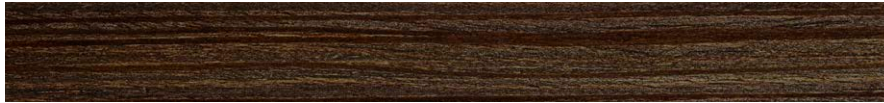

Shadow Zebrano veneer



Dark Grey Oak veneer



Grand Black veneer¹

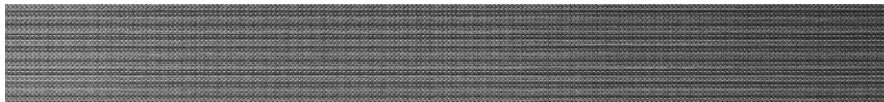

Micro Mesh Aluminium trim finisher



Dark Satin Brushed Aluminium trim finisher



Dark Engine Turned Aluminium trim finisher



Extended Carbon Fibre trim finisher^{3,4}

SVR ONLY



Extended Satin Brushed Aluminium trim finisher

³Denotes availability on SVR model. ⁴Carbon Fibre trim finisher adds Carbon Fibre bezel on SVR steering wheel.



CHOOSE YOUR OPTIONS AND LAND ROVER GEAR

A wealth of line-fit options are available to select from at the point of ordering your new vehicle, to help you express your individuality and appoint your Range Rover Sport with the premium features you require. Features and their availability may differ by vehicle specification and market. For full feature and option availability please refer to the accompanying Specification and Price Guide or visit your local Land Rover Retailer.





EXTERIOR FEATURES

Powered gesture tailgate (see page 45)
Soft door close.

GLASS AND EXTERIOR MIRRORS

Auto-dimming exterior mirrors (driver's side only)
Power fold exterior mirrors
Privacy rear side glass
Heated windscreen
Solar attenuating windscreen to reduce temperature build-up within cabin.

ROOF OPTIONS

See page 64.

EXTERIOR STYLING

See pages 68-71
Carbon Fibre engine cover (SVR only).

WHEELS

See pages 72-73
Summer tyres
Tyre Repair System
Reduced section alloy spare wheel
Full size spare wheel.

INTERIOR FEATURES

Carpet mats*
Premium carpet mats with bound edging*
Heated steering wheel
Aluminium treadplates with Range Rover script
Illuminated aluminium treadplates with Range Rover script*
Twin-blade sunvisors with illuminated vanity mirrors
Front centre console cooler compartment
Front centre console refrigerator compartment (see page 44)
Configurable Ambient Interior Lighting (see page 13)
Three-zone Climate Control
Four-zone Climate Control - with independent rear HEVAC unit and additional vents (see page 43)
Cabin Air Ionisation (see page 43)
Black gearshift paddles
Satin Chrome gearshift paddles
Climate Comfort Pack - Sliding panoramic roof, heated windscreen, solar attenuating windscreen, extra large washer bottle, heated steering wheel, twin bladed sunvisors with illuminated vanity mirrors, front centre console refrigerator compartment, Four-zone Climate Control
Cold Climate Pack - Heated windscreen, heated steering wheel, Four-zone Climate Control, cabin pre-conditioning with remote
Comfort and Convenience Pack - Auto-dimming exterior mirrors, powered gesture tailgate, 16-way memory front seats, Keyless Entry

Convenience Pack - Powered gesture tailgate, 60:40 load through rear seats, electrically adjustable steering column, Keyless Entry, soft door close

Comfort and Convenience Pack - Auto-dimming (driver's side only), power fold, heated door mirrors with memory and approach lights, powered gesture tailgate, 16-way memory front seats, Keyless Entry

Luxury Pack - Massage front seats, 22-way memory front seats with winged headrests, premium carpet mats, Extended Leather Upgrade, suedecloth headlining.

HEADLINING

Ebony headlining
Suedecloth headlining.

SEATING

Front seats: 16/20/22-way, heated, cooled, massage
Rear seats: 60:40, 60:40 with load through, heated/cooled
Two third row seats
Windsor leather and Semi-Aniline leather.

DRIVING DYNAMICS

Off-Road Pack (SDV6 249PS engine only) - Twin-speed Transmission, All Terrain Progress Control, Terrain Response 2, Adaptive Dynamics (TDV6 and 3.0L V6 Supercharged only)

On/Off-Road Pack - Twin-speed Transmission, All Terrain Progress Control, Dynamic Response, Electronic Active Rear Differential with Torque Vectoring by Braking, Terrain Response 2 with Dynamic Program

Grey anodised brake calipers with Land Rover script
Black brake calipers (SVR only).

INFOTAINMENT AND AUDIO

See pages 25-29

Domestic plug socket located in row two and loadspace (5 + 2 seat vehicles row two only) (see page 44)

Entertainment Pack - Meridian™ Surround Sound System (see page 28), CD/DVD player, 8" Rear Seat Entertainment (see page 25), Digital TV (see page 25), domestic plug socket located in row two and loadspace

Signature Entertainment Pack - Meridian™ Signature Sound System (see page 30), CD/DVD player, 10" Rear Seat Entertainment (see page 25), Digital TV (see page 25), domestic plug socket located in row two and loadspace

Connect Pro Pack (see pages 26-27).

SECURITY

Intrusion sensor

Keyless Entry

Activity Key (see page 45).

ADVANCED DRIVER ASSISTANCE SYSTEMS

Adaptive Cruise Control with Steering Assist

360° Surround Camera (see page 34)

Wade Sensing (see page 23)

Head-up Display (see page 25)

Drive Pack (see page 31)

Drive Pro Pack (see page 31)

Park Pack (see page 33)

Park Pro Pack (see page 33)

Adaptive Cruise Control (see page 30)

Driver Assist Pack (see pages 34-35).

HEADLIGHTS AND LIGHTING

See page 41

Vision Assist Pack - Auto High Beam Assist (AHBA) (see page 41), auto-dimming exterior mirrors, Head-up Display (see page 25), auto-dimming exterior mirrors, auto-dimming interior rear view mirror

Vision Assist Pro Pack - Auto-dimming exterior mirrors (driver's side only), front fog lights, Pixel-laser LED headlights with signature DRL (see page 41), auto-dimming interior rear view mirror, Configurable Ambient Interior Lighting (see page 13), Head-up Display (see page 25).

TOWING

Electrically deployable tow bar (see page 47)

Advanced Tow Assist (see page 47).



LAND ROVER GEAR – ACCESSORIES

DESIGN

Front / Rear Undershield

The off-road inspired Undershield, manufactured from stainless steel, features a premium Bright Polished finish for the front or rear of the vehicle.

Noble Chrome Mirror Covers VPLGB0073

Noble Chrome plated mirror covers are designed to enhance Range Rover Sport's exterior styling cues. This neat styling upgrade complements various Dark Atlas, Light Atlas and Bright finish exterior trim.

Sport pedal covers

Alternative pedal covers for an interior styling enhancement featuring a Bright finish. Manufactured from polished and etched stainless steel and features hidden fixings for a clean finish.

Illuminated treadplates

Illuminated treadplates with Range Rover lettering and halo surround. Rear treadplates feature illuminated halo only.

Personalised illuminated treadplates

Personalised illuminated treadplates allow you to choose a personalised message using an approved set of fonts/typefaces which will be highlighted in white illumination when the front doors are open.

Gearshift paddles

Complete the look and feel of your steering wheel with premium aluminium paddles. Gearshift paddles are machine polished, anodised and hand brushed to provide exceptional wear resistance with a premium finish.



Front Undershield

LIFESTYLE

Deployable side steps

These smart, practical steps make it easier to get in and out of the vehicle. Neatly stowed under the sills, the side steps automatically deploy as soon as the door is opened, or when activated by the key fob. The side steps are sensitive to obstructions and will not deploy in off-road or low-range settings. Featuring a stainless steel finish with laser etched Range Rover branding.

Fixed side steps

Complete with a rubber tread mat and brushed stainless steel trim, the fixed side steps provide easy access/exit to the vehicle's cabin and aid access to the roof. With embossed Range Rover branding, exterior Bright work and Bright anodised aluminium edge trim finish.

Rubber mats - LHD

Rubber footwell mats for front and second row occupants helps provide protection from general dirt. Featuring Bright accent Range Rover ingot and durable metal corner pieces.

Click and Go System

The Click and Go range is a multi-purpose seat-back system for second row passengers. The versatile Click and Go Base fixes between the headrest mountings and further attachments can be added to hold tablets, bags and shirts or jackets. Each attachment is sold separately. The base can be easily removed when not in use.



Deployable side step

SPORTING

Tow Bar Mounted Bike Carrier

The Tow Bar Mounted Bike Carrier features a one hand, quick attach/release tow bar coupling mechanism and can be tilted away from the vehicle, by use of a foot pedal, to allow easy access into the rear tailgate. Maximum load capacity 40kg for two bikes and 51kg for three bikes.

Sports roof box

The sleek, aerodynamically designed sports roofbox with a Gloss Black finish can be mounted on either side of the vehicle for kerbside opening and is lockable for security.

Sports roof box ski/snowboard inserts

Featuring an optional internal retention system for skis or other long loads.

Roof Mounted Bike Carrier

Roof Mounted, lockable Bike Carrier designed for holding a single bike, up to 20kg.

Aqua Sports Carrier

Carries a sailboard, canoe or kayak. Includes lockable multi-purpose holder to carry oars or paddles. Tilts to facilitate easy loading/unloading. Features lockable straps and rubber supports to maintain optimum weight distribution whilst protecting the kayak and vehicle from scratches/scuffs. Maximum load capacity 45kg.

Ski/Snowboard Carrier

Carries four pairs of skis or two snowboards, and incorporates slider rails for easy loading and is lockable for security. Maximum payload 36kg.



Roof Mounted Bike Carrier

OUTDOOR

Tailgate Event Seating in Ebony leather

The tailgate event seating is handcrafted from beautiful Ebony Windsor leather with a highly durable aluminium frame. Stowed in the loadspace, these seats can be quickly and easily fitted to provide comfortable seating for two adults on the lower tailgate, when the vehicle is stationary.

Mudflaps

Mudflaps are a popular upgrade for reducing spray and ensuring paintwork is protected from debris and dirt. Designed to complement the vehicle's exterior styling.

Centre armrest cooler/warmer box

Food and drinks cooler and warmer that acts as a rear centre armrest. With a leather-covered top, it is held in place by the centre seat belt and powered from the rear auxiliary socket. Ideal for long journeys with the family.

Roof rails

Roof rails facilitate easy fitment of cross bars for roof carrying. Preset positioning points ensure cross bars are fixed in the optimum position for weight distribution and dynamics.

Cross bars

Elegant, durable Bright finish aluminium cross bars, with T-track design providing space to mount multiple accessories by utilising the full length of the bars. Aerodynamic profile minimises drag and wind noise. The incremental height when fitted is 93mm.



Tailgate Event Seating in Ebony leather



TOURING

Public charging cable

The public charging cable provides an upgrade from the standard home charging cable, helping to reduce the time required for charging. The six metre long, public cable can be used with a universal style A/C wall box (which does not feature a tethered cable), to provide a fast charging solution at home. Alternatively it is compatible with public charging points.

iPhone Connect and Charge Dock

The iPhone Connect and Charge Dock has been designed to charge utilising the cup holder space in the central console. When connected, the iPhone's media is accessible and has the ability to be controlled via the integrated infotainment/audio system. The 'cut-out' design of the holder is such that the home button is also accessible for use when parked.

Wireless Phone Charging Cup Holder

The wireless phone charging cup holder has been designed to charge utilising the cup holder space in the centre console. The holder will accommodate varying phone sizes securely in place. The charger displays an LED light to indicate when charging, and turns off when complete. Fits phones up to 72mm wide.



iPhone Connect and Charge Dock

PET PRODUCTS

Pet Transportation Pack

Convenient option to provide a comfortable environment for transporting pets, which can be fitted or removed quickly as and when required. Combines the Foldable Pet Carrier, Spill Resistant Water Bowl and Loadspace Rubber Mat. The perfect solution for owners who regularly carry dogs or other pets in the loadspace area of their vehicle.

Pet Care and Access Pack

Taking the effort out of transporting pets, this option ensures everything required is to hand to transport pets in comfort. Combines the full height luggage partition, quilted loadspace liner, Pet Access Ramp and portable rinse system. The perfect solution for owners who regularly carry dogs or other pets in the loadspace area of their vehicle.

Pet Loadspace Protection Pack

Designed to provide protection and easy cleaning of the loadspace from wet and muddy paws. Combines the quilted loadspace liner, full height luggage partition and Spill Resistant Water Bowl. The perfect solution for owners who regularly carry dogs or other pets in the loadspace area of their vehicle.

Quilted loadspace liner*

This tailored liner covers and protects all the carpeted areas of the loadspace area including the floor, second row seat backs and loadspace side walls. Manufactured from a soft quilted fabric, with an integral rubber mat and detachable bumper protector it is easy to wipe clean, making it ideal for owners who regularly carry dogs or other pets in the loadspace area of their vehicle.



Pet Transportation Pack

*Not available with P400e.

THE WORLD OF LAND ROVER

Your Land Rover has been designed and engineered to help you make more of your world. It can take you to places other vehicles simply can't reach, in a style that cannot be matched. To celebrate the Land Rover lifestyle, we've put together a range of experiences, publications and the Land Rover Lifestyle Collection. There's a world to explore. Get out there and enjoy it.

EXPERIENCE DRIVES



Bring out your adventurous side and experience Land Rover's legendary capability for yourself. Under the expert guidance of a world-class instructor, head to the most exciting and challenging off-road terrains and take the vehicle to its limits.

landrover-me.com/experiences

ADVENTURE TRAVEL



From the sheer exhilaration of the Arctic ice to the awe-inspiring dunes of Namibia, Land Rover Adventure Travel offers you once-in-a-lifetime experiences that bring the spirit and emotion of our vehicles to life.

landrover-me.com/experiences/adventure-travel

Follow us on:



MANUFACTURING TOURS



This is a unique opportunity to step inside our state-of-the-art manufacturing facilities and see where the latest vehicles are born. Taking you behind the scenes, our expert tour guides will show you how Land Rover combines unrivalled craftsmanship with cutting-edge robotics.

[landrover.com/tours](https://www.landrover.com/tours)

SPECIAL VEHICLE OPERATIONS



Whether it's class-leading luxury, thrilling performance or extreme all-terrain capability, Land Rover excels. Special Vehicle Operations takes this even further. Delivering the absolute pinnacle of Land Rover engineering and design, each vehicle combines peerless refinement with power and cutting-edge technology, which is why the SV badge represents so much.

[landrover-me.com/special-vehicle-operations/special-vehicles](https://www.landrover-me.com/special-vehicle-operations/special-vehicles)

THE LAND ROVER LIFESTYLE COLLECTION



Our latest range of clothing and lifestyle accessories are crafted with the same design excellence and attention to detail as our vehicles. Inspired by our unique heritage, there is something for the whole family.

landrover-me.com/branded-goods

ONELIFE MAGAZINE



Free twice a year for your first three years as a Land Rover owner, this award-winning magazine features the best in photography, authoritative journalism and expert insights. Onelife takes you right into the heart of exclusive experiences and extraordinary adventures, whilst keeping you up to date with the latest innovations, design and lifestyle choices.

landrover.com/onelife

Follow us on:



BRAND PARTNERSHIPS



Integrity. Courage. Pride. These are the values that Land Rover shares with its partners. Whether it's the Invictus Games, Virgin Galactic, Rugby World Cup 2019™ or the British and Irish Lions, each one is driven by exceptional people. Those who push their capabilities to the very limits and champion the determination to go above and beyond.

landrover-me.com/experiences/sponsorship

HUMANITARIAN PARTNERSHIPS



Since 1954, Land Rover is proud to have supported the incredible humanitarian work of the International Federation of Red Cross and Red Crescent Societies (IFRC). Through vehicles, funding and combined expertise, this ambitious global partnership has helped to transform the lives of over one million people, across four continents.

landrover-me.com/explore-land-rover/responsibility



YOUR PEACE OF MIND

CUSTOMER SERVICE

When you bring your Land Rover to us, we use cutting-edge diagnostic equipment to assess all your vehicle's mechanical and electronic systems. Our qualified Technicians use tools specifically designed for our vehicles and only fit genuine Land Rover parts and Gear accessories. A choice of service plans are available which, together with Roadside Assistance, ensures complete peace of mind.

For further details contact your local Land Rover Retailer or search 'Land Rover Ownership'.

LAND ROVER ROADSIDE ASSISTANCE

Land Rover Assistance provides assistance in motoring emergencies, from immobilisation due to breakdown or accident to minor problems such as punctures. You can rely on our roadside assistance, whatever the situation, wherever you happen to be.

For further details please consult your Warranty Benefits handbook, contact your nearest Land Rover Approved Service Centre or search 'Land Rover Roadside Assistance'.

IMPORTANT NOTICE: Jaguar Land Rover Limited is constantly seeking ways to improve the specification, design and production of its vehicles, parts and accessories and alterations take place continually. Whilst every effort is made to produce up-to-date literature, this brochure should not be regarded as an infallible guide to current specifications or availability, nor does it constitute an offer for the sale of any particular vehicle, part or accessory. Distributors and Retailers are not agents of Jaguar Land Rover Limited by any express or implied undertaking or representation.

Images are for illustrative purposes only. Colours reproduced on-screen may vary compared to actual finish. The company reserves the right to alter or withdraw any colour finish without notice. Some of these colours may not be obtainable in your country. Please check availability of colours and current specifications with your Land Rover Retailer. Distributors and Retailers are not agents of Jaguar Land Rover Limited and have absolutely no authority to bind Jaguar Land Rover Limited to any express or implied undertaking or representation.

TECHNICAL SPECIFICATION

If not enclosed, please contact your local Land Rover Retailer.

LAND ROVER FINANCIAL SERVICES

Getting the keys to your very own Land Rover has never been so simple. And it's more affordable than you might think. New or used, for personal or business use, we have an option that puts you in complete control.

For further details contact your local Land Rover Retailer or search 'Land Rover Finance'.

FLEET & BUSINESS

Land Rover is dedicated to being the premium manufacturer of choice for fleets and businesses, by providing a highly attractive range of vehicles and exemplary customer service. Distinctive, capable and versatile, all Land Rover vehicles deliver low Total Cost of Ownership through strong residual values, competitive service, maintenance and repair costs, and impressive fuel economy and CO₂ emissions.

We are also committed to providing a totally customer-focused aftersales service, which will ensure every Land Rover vehicle is kept on the road and in top condition, in the easiest and most cost-efficient way for businesses.

Search 'Land Rover Fleet and Business' for full details.

Castrol EDGE Professional exclusively recommended by Land Rover.

Vehicle shown is Autobiography with Dynamic Pack and Bright Pack in Fuji White with optional features fitted (market dependent).

Jaguar Land Rover Limited

Registered Office: Floor 7, Wing E,
HQ Building, Dubai Silicon Oasis,
P.O. Box 32588, Dubai UAE

Registered in England Number: 1672070

landrover-me.com/RangeRoverSport

© Copyright Jaguar Land Rover Limited 2020.

1L4942010000BXMEN02P

